

## Nationale Hinterlegungen

In der folgenden Liste werden die beim Eidgenössischen Institut für Geistiges Eigentum hinterlegten Designs publiziert. Dabei sind der Reihe nach angegeben:

- internationale Klassenangaben
- Hinterlegungsnummer
- Hinterlegungsdatum
- Allenfalls Aufschub der Veröffentlichung
- Anzahl der hinterlegten Designs
- Bezeichnung
- Name und Wohnsitz des Hinterlegers oder der Hinterlegerin
- gegebenenfalls Name und Wohnsitz des Designers oder der Designerin
- Name und Geschäftssitz des allfälligen Vertreters oder der Vertreterin
- gegebenenfalls Prioritätsangaben
- gegebenenfalls Beschreibungstext
- Ordnungsnummer
- Reproduktion des Designs

## Internationale Hinterlegungen

Die bei der Weltorganisation für geistiges Eigentum in Genf hinterlegten Muster und Modelle mit Benennung Schweiz geniessen den gleichen Schutz wie national hinterlegte Designs. Sie werden jeweils im Blatt «Bulletin des dessins et modèles internationaux» veröffentlicht. Dieses Publikationsorgan ist deshalb für eine vollständige Recherche unbedingt beizuziehen.

## Topographien

Angaben über die vom Eidgenössischen Institut für Geistiges Eigentum eingetragenen Topographien von Halbleitererzeugnissen werden in folgender Anordnung aufgeführt:

- Eintragsnummer
- Anmeldedatum
- Bezeichnung
- Name und Wohnsitz des Anmelders oder der Anmelderin
- gegebenenfalls Name und Wohnsitz des Herstellers oder der Herstellerin
- Name und Geschäftssitz des oder der allfälligen Bevollmächtigten
- Datum und Ort einer allfälligen ersten geschäftlichen Verbreitung der Topographie

## Dépôts nationaux

Les designs déposés à l'Institut Fédéral de la Propriété Intellectuelle sont publiés dans la liste qui suit. Les indications y relatives sont mentionnées dans cet ordre:

- indications des classes internationales
- numéro de dépôt
- date de dépôt
- le cas échéant, ajournement de la publication
- nombre des designs déposés
- désignation
- nom et domicile du/de la déposant/e
- le cas échéant, nom et domicile du/de la designer
- nom et domicile de l'éventuel/le mandataire
- le cas échéant, indication de priorité
- le cas échéant, description du design
- numéro attribué à chaque design
- reproduction du design

## Dépôts internationaux

Les dessins et modèles déposés à l'Organisation Mondiale de la Propriété Intellectuelle à Genève qui désignent la Suisse jouissent de la même protection que les dépôts nationaux. Ils sont chaque fois publiés dans la feuille «Bulletin des dessins et modèles internationaux». Pour une recherche complète, il est indispensable de consulter ledit organe de publication.

## Topographies

Les indications concernant les topographies des produits semi-conducteurs, enregistrées par l'Institut Fédéral de la Propriété Intellectuelle, sont énumérées dans l'ordre suivant:

- numéro d'enregistrement
- date de dépôt
- désignation
- nom et domicile du/de la déposant/e
- le cas échéant, nom et domicile du/de la producteur/trice
- nom et domicile de l'éventuel/le mandataire
- date et lieu d'une éventuelle première mise en circulation de la topographie

## Depositi nazionali

Nella lista seguente vengono pubblicati i design depositati presso l'Istituto Federale della Proprietà Intellettuale. Sono menzionati nel seguente ordine:

- indicazioni delle classi internazionali
- numero di deposito
- data del deposito
- se del caso, indicazione che la pubblicazione è stata differita
- numero dei design depositati
- designazione
- nome e domicilio del depositante
- se del caso, nome e domicilio del designer
- nome e sede di un eventuale mandataro
- se del caso, indicazioni di priorità
- se del caso, descrizione del design
- numero d'ordine
- riproduzione del design

## Depositi internazionali

I disegni e modelli depositati presso l'Organizzazione Mondiale della Proprietà Intellettuale a Ginevra con denominazione Svizzera godono della medesima protezione del deposito nazionale. Essi vengono pubblicati ogni volta nel foglio «Bulletin des dessins et modèles internationaux». Quest'organo di pubblicazione è da consultare se si vuole effettuare una ricerca completa.

## Topografie

Le indicazioni concernenti le topografie di prodotti a semiconduttori depositati presso l'Istituto Federale della Proprietà Intellettuale sono menzionate nell'ordine seguente:

- numero di registrazione
- data del deposito
- designazione
- nome e domicilio del/la richiedente
- se del caso, nome e domicilio del/la produttore/trice
- nome e sede di un eventuale mandataro
- data e luogo di un'eventuale prima messa in circolazione della topografia

## Hinterlegungen Dépôts Deposit

Cl. 09-03 131 935 12.07.2005  
 8 Design – Dosen  
 Hinterleger: Hoffmann Neopac AG, Eisenbahnstrasse 71,  
 3602 Thun  
 Designer: Thomas Liebe, Thun; Markus Fankhauser,  
 Herbligen; Matthias Hammersen, Dinklage; Martin Presche,  
 Lohne; Holger Hagen, Lohne  
 Vertreter: Advokaturbüro Beutler Künzi Stutz, 3000 Bern 6  
 Ende aufgeschobene Publikation

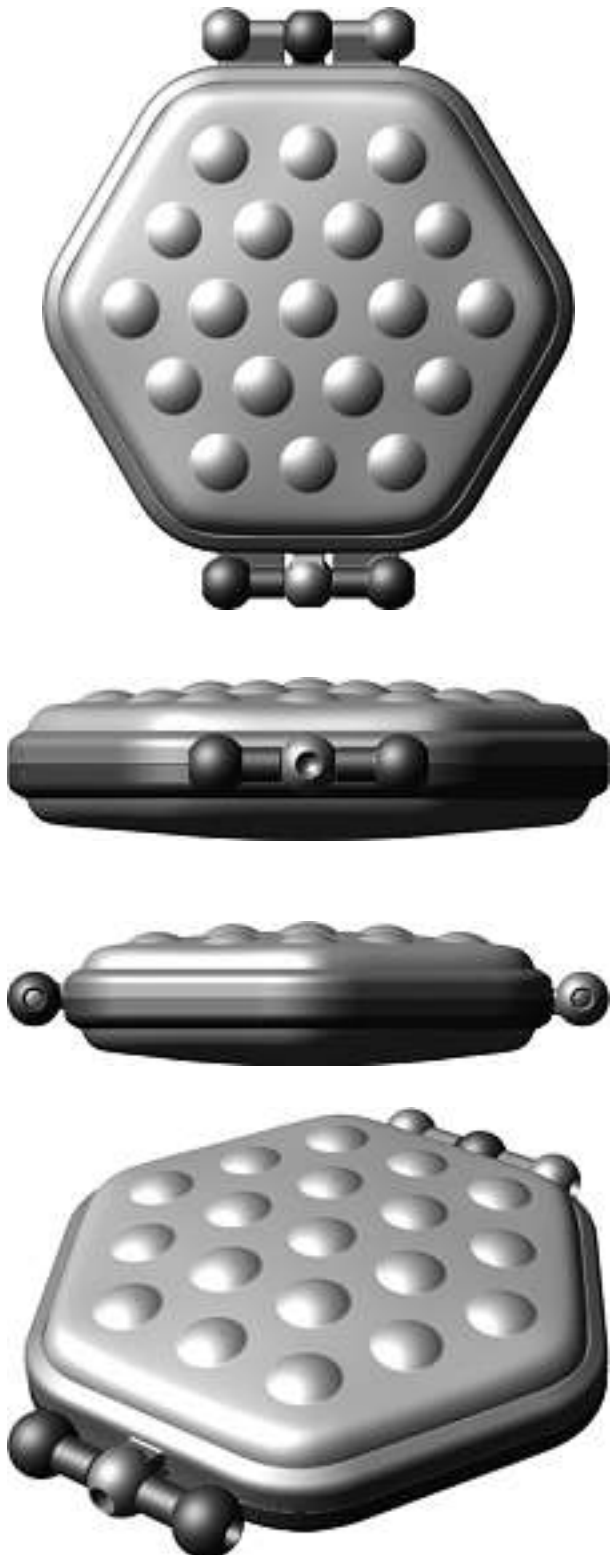



2

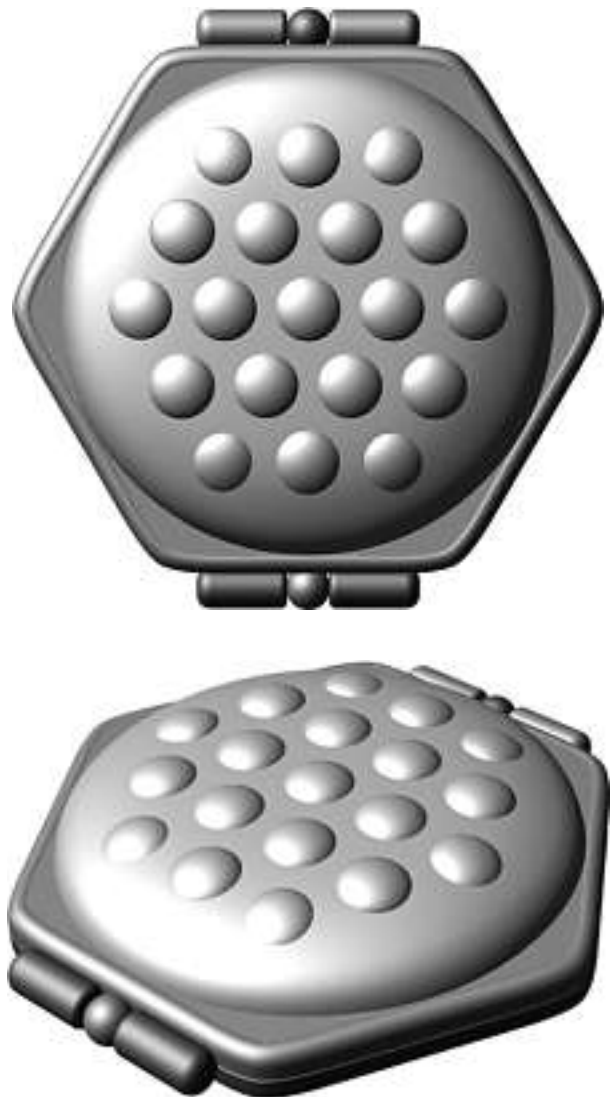

3

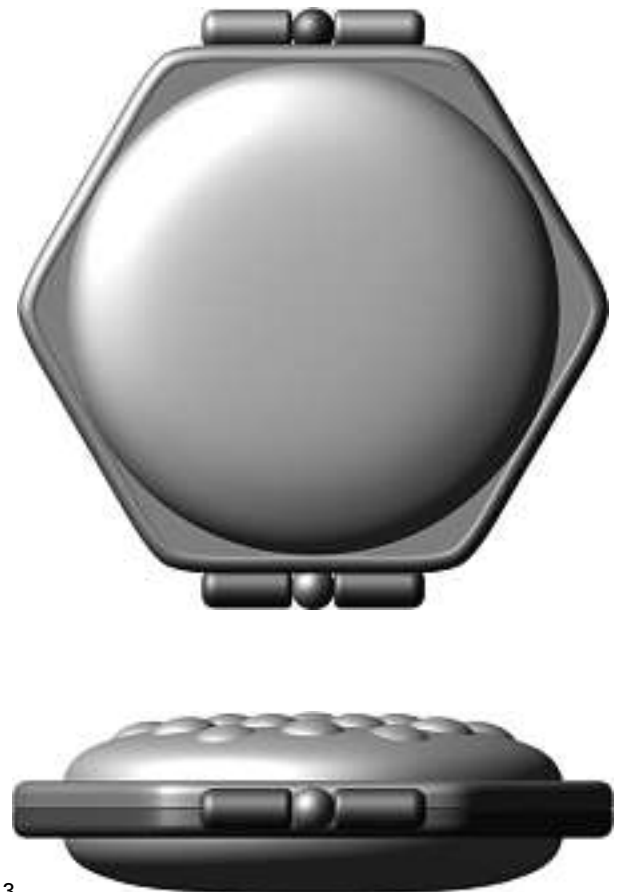



4





5



6



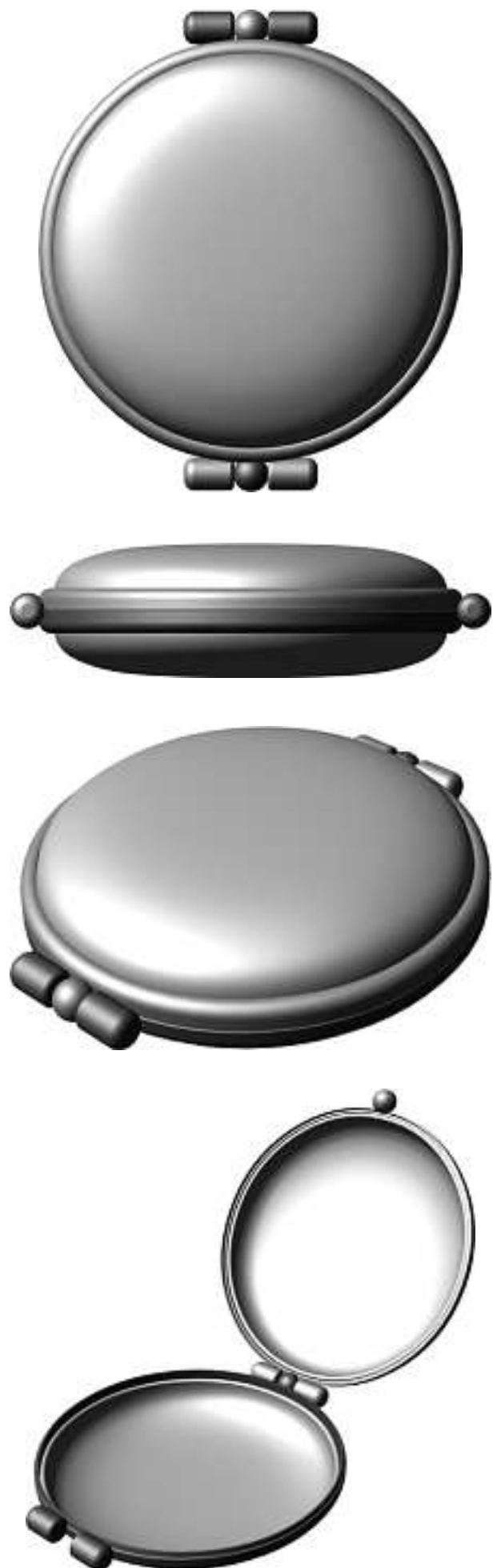
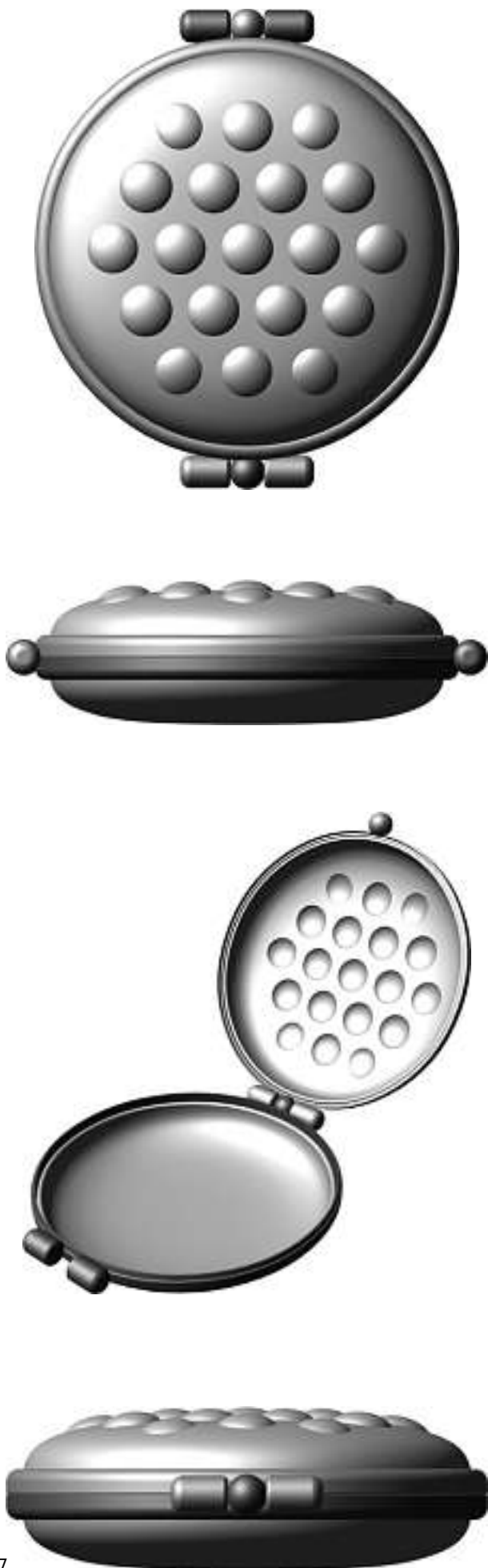



8

Cl. 11-01 132 127 13.09.2005  
 1 design – bijoux  
 Déposant: Robert Jaccard, Place du Temple 4, 1227 Carouge  
 Mandataire: Bugnion S.A., 1211 Genève 12 - Champel  
 Fin de la période ajournement de la publication



1

Cl. 28-01 132 376 28.11.2005  
 4 Design – Tabletten  
 Hinterleger: Nycomed Pharma AS, Drammensveien 852,  
 P.O. Box 205, 1372 Asker, NO  
 Designer: Carsten Martini Nielsen, Søborg; Peder Mohr  
 Ohlsen, Kr. Hillinge  
 Vertreter: A. Braun, Braun, Héritier, Eschmann AG,  
 Patentanwälte, 4051 Basel  
 Priorität: EM, 30.05.2005  
 Ende aufgeschobene Publikation

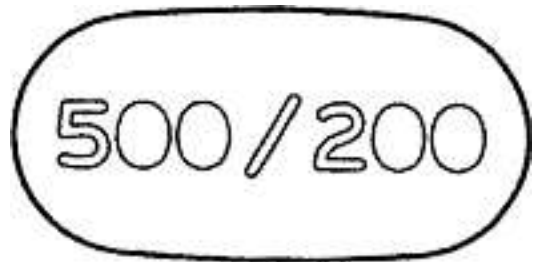
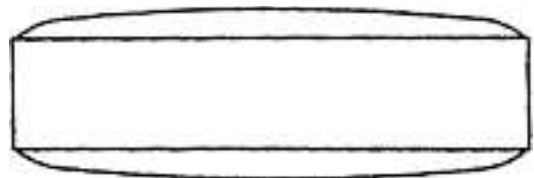

1

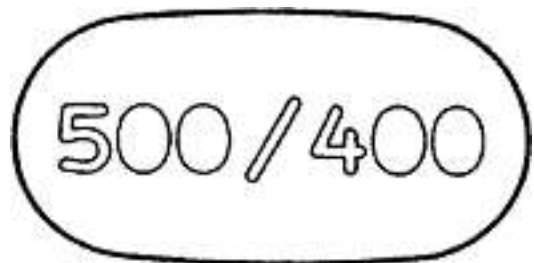
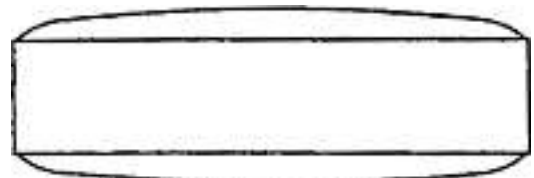

2

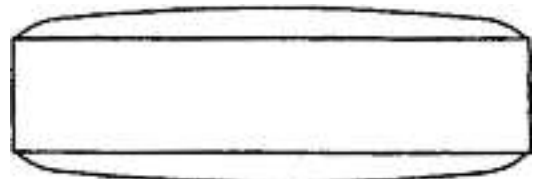

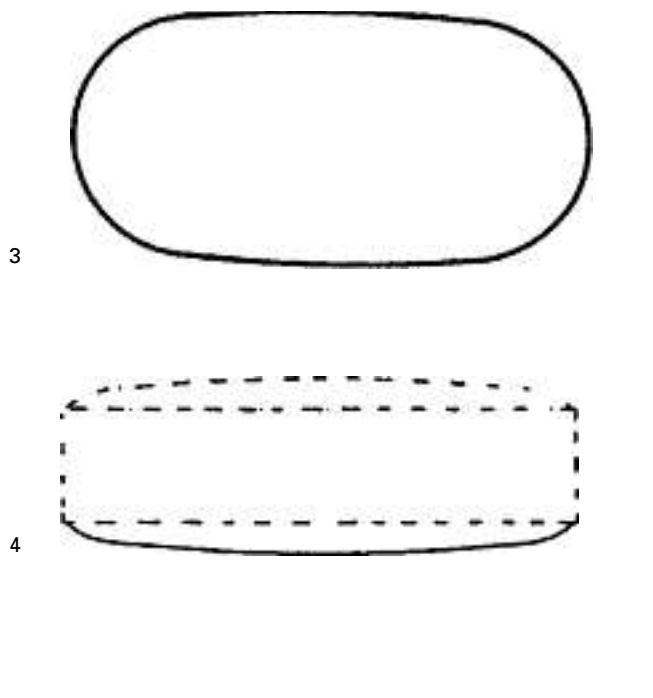

Cl. 12-08                      **132 530**                      12.01.2006  
 1 design – automobile  
 Depositante: Honda Motor Co., Ltd., No. 1-1, 2-chome,  
 Minami-aoyama, Minato-ku, Tokyo, JP  
 Designer: Daisuke Sawai, Saitama; Naoya Ishikura, Saitama;  
 Deane James, Saitama  
 Mandatario: Fiammenghi-Fiammenghi, 6900 Lugano  
 Priorità: JP, 22.07.2005  
 Fine del periodo di differimento della pubblicazione



467

Cl. 26-06                      **132 538**                      12.01.2006  
 2 design – gruppi ottici anteriori e posteriori per autovettura  
 Depositante: Honda Motor Co., Ltd., No. 1-1, 2-chome,  
 Minami-aoyama, Minato-ku, Tokyo, JP  
 Designer: Naoya Ishikura, Saitama; Deane James, Saitama  
 Mandatario: Fiammenghi-Fiammenghi, 6900 Lugano  
 Priorità: JP, 13.07.2005; JP, 13.07.2005  
 Fine del periodo di differimento della pubblicazione





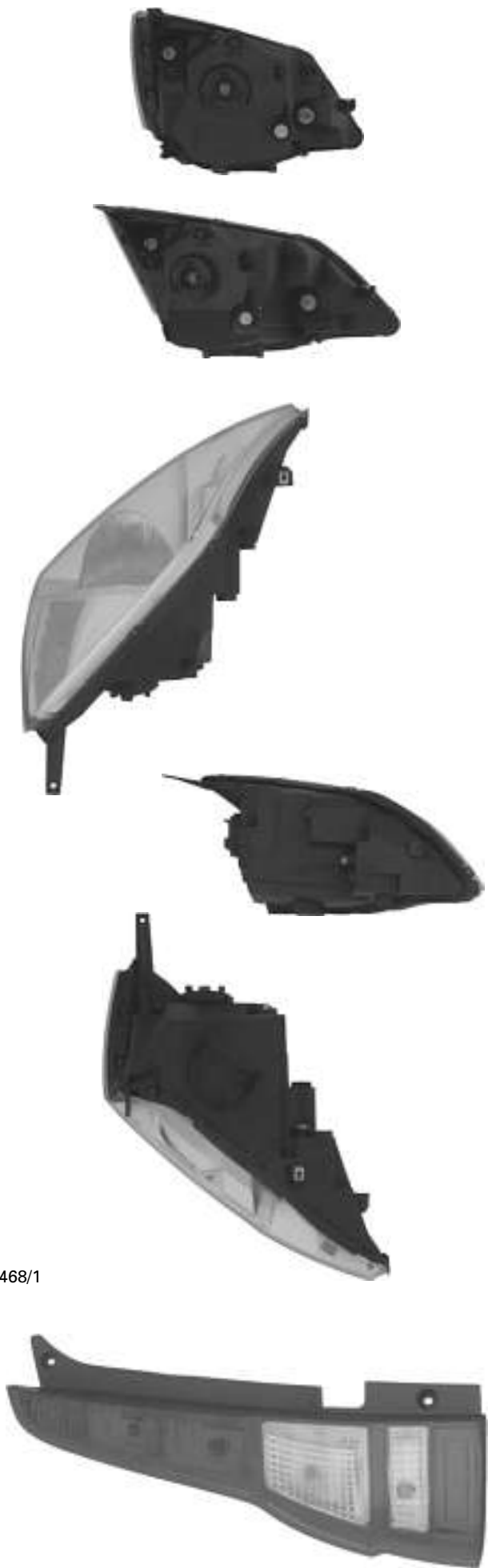

468/1





468/2

Cl. 09-03 132 559 25.01.2006

1 Design – Lebensmittelbehälter  
 Hinterleger: Hilcona Aktiengesellschaft, Bendererstrasse 21,  
 9494 Schaan, LI  
 Designer: Jürgen Hilti, Schaan  
 Vertreter: A.W. Metz & Co. AG, 8024 Zürich  
 Priorität: EM, 13.10.2005  
 Ende aufgeschobene Publikation

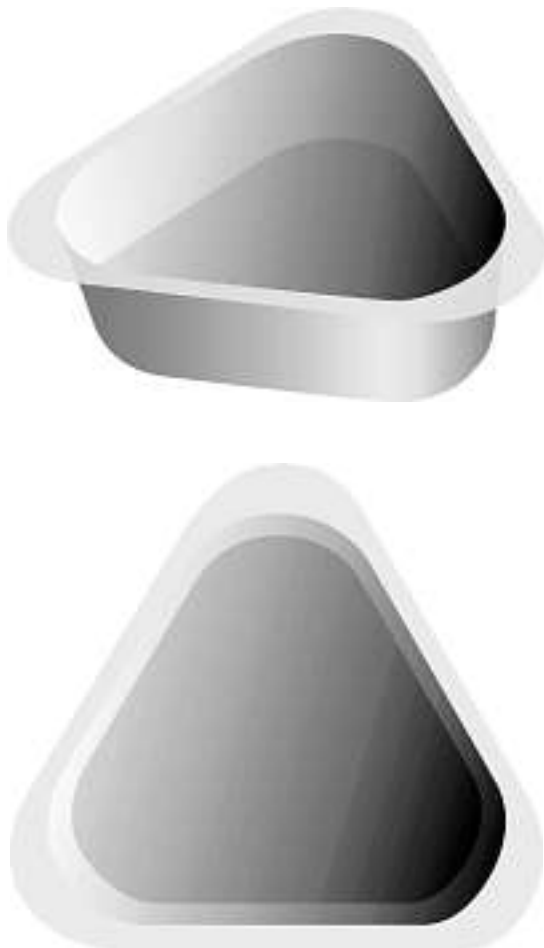

467-CH-9-DD

Cl. 10-02 132 644 15.03.2006

1 design – montre-bracelet  
 Déposant: Luxury Timepieces International SA,  
 Ch. des Rochettes 2, 2016 Cortaillod  
 Designer: Frida Giannini, Firenze  
 Mandataire: Inteltech SA, 2001 Neuchâtel  
 Fin de la période ajournement de la publication





Harper

Cl. 02-04 **134 703** 29.10.2007  
 8 Design – Schienbeinschützer  
 Hinterleger: Task Force Properties & Investments Ltd.,  
 Millennium House, Moss Road, Witham, Essex CM8 3 UQ, GB  
 Designer: Harald Scheffer, Merzig  
 Vertreter: A.W. Metz & Co. AG, 8024 Zürich  
 Priorität: EM, 30.04.2007; EM, 30.04.2007; EM, 30.04.2007;  
 EM, 30.04.2007

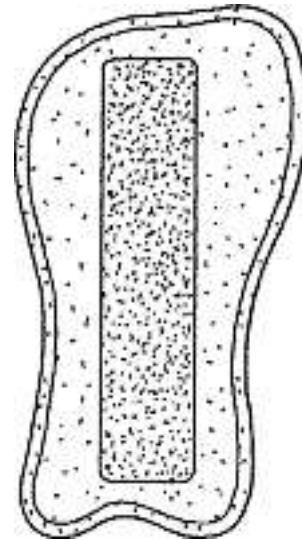

1

Cl. 01-01 **134 702** 23.01.2008  
 1 Design – Lebensmittel  
 Hinterleger: Thomas Walter Siegrist, Sonnenbergstrasse 51,  
 5408 Ennetbaden

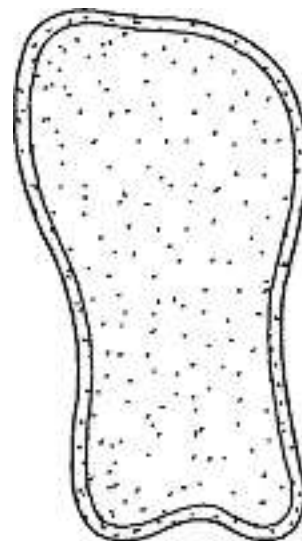

1

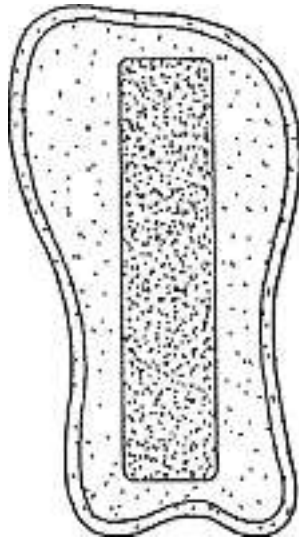

3

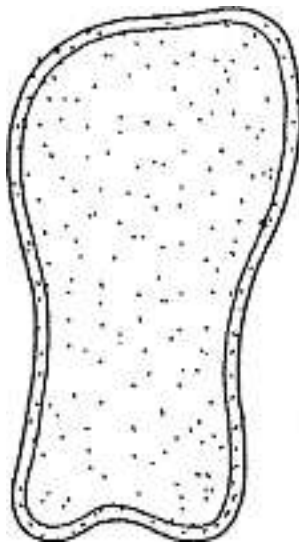
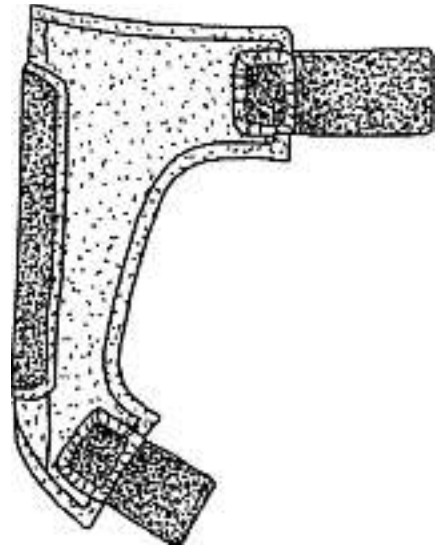

4

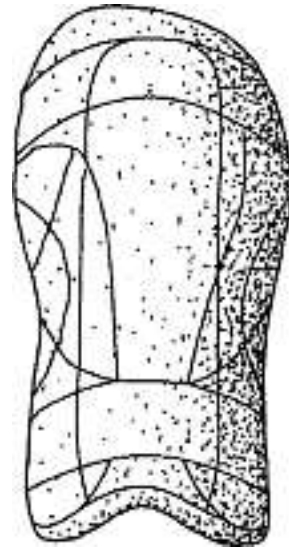

2

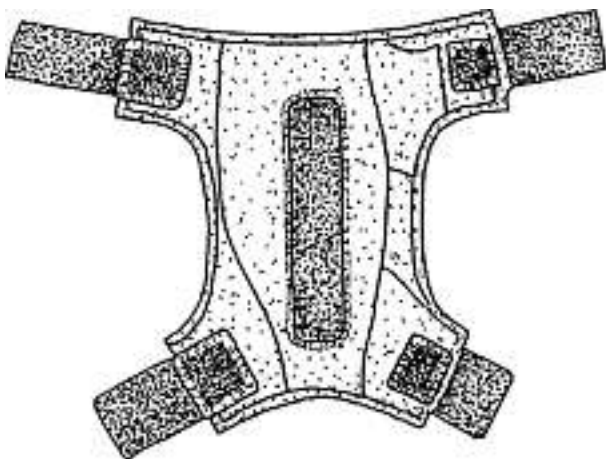

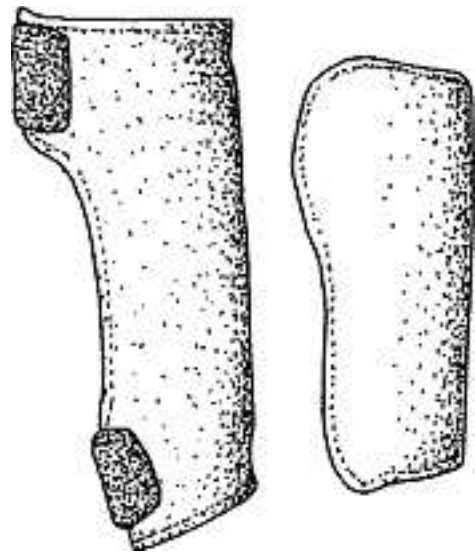
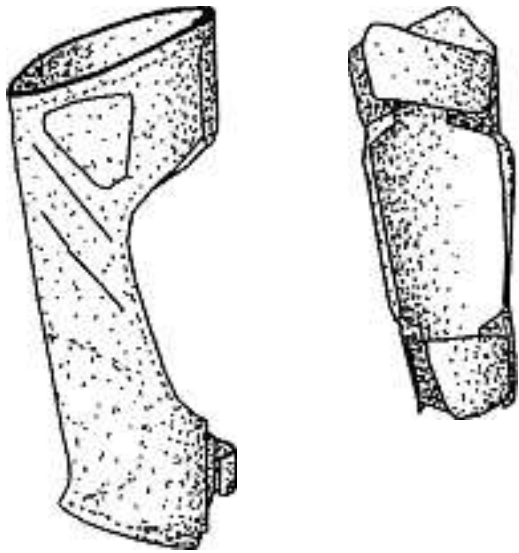

6

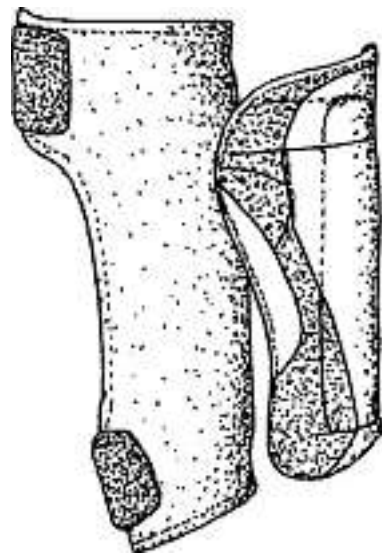
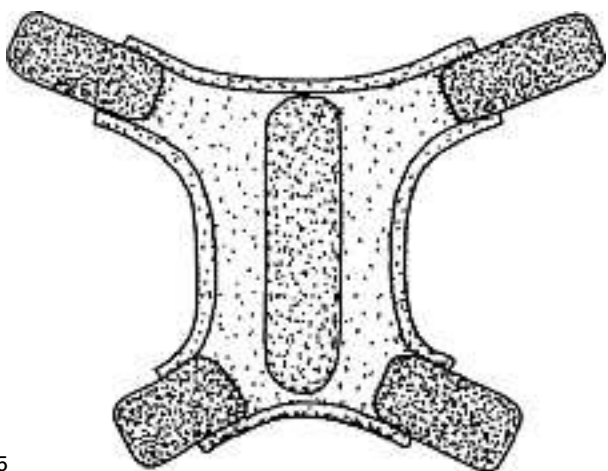
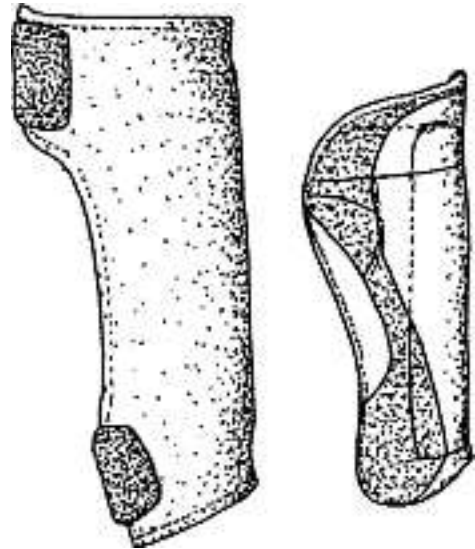
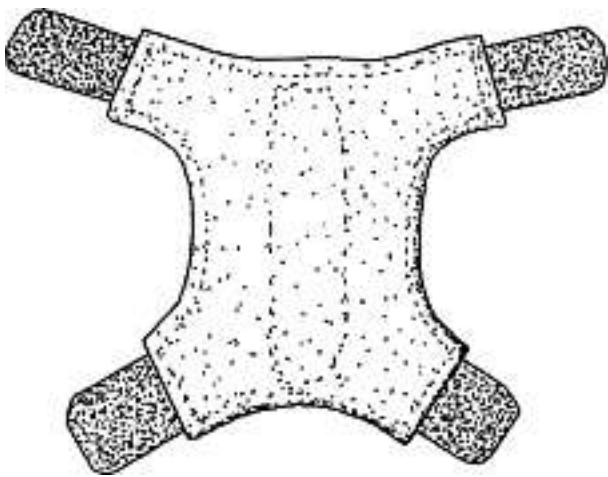

5

7

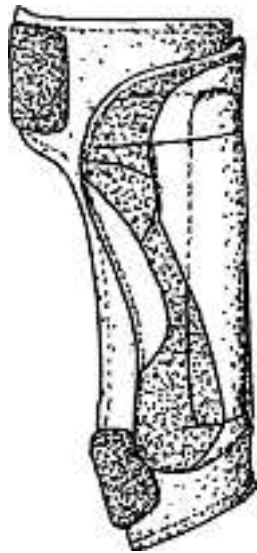

8

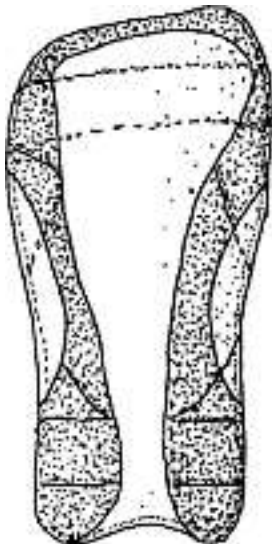

Cl. 02-04                      **134 704**                      24.01.2008  
 3 Design – Schuhe  
 Hinterleger: Crocs, Inc., 6328 Monarch Park Place, Niwot, CO,  
 US  
 Designer: Stefano del Biondi, Noventa Padovana;  
 Marianna Zuin, Villatora di Saonara; Alessio Zagallo,  
 Rosara di Codevigo  
 Vertreter: Keller & Partner Patentanwälte AG, 3000 Bern 7  
 Priorität: US, 27.07.2007





1



2





3

Cl. 03-01 134 705 04.01.2008

1 Design – Kärtchen-Box

Hinterleger: VSB Verlag für Schule und Beruf,  
Oswald Leitner, Largitzenstrasse 33, 4056 Basel

Designer: Markus Meyer, Binningen; Bengt Sprinzl, Wien

Beschreibung des Designs: Form: Die think&click-Kartonbox besteht aus einem Aussenteil, der an vier Punkten verklebt wird, und einem Innenteil, der lose eingeschoben wird. Beim Schliessen der Kartonbox entsteht ein deutliches Klickgeräusch. Layout: Die Vorderseite trägt an der oberen linken Ecke eine Wort-Bild-Marke in Form eines Dreiecks, das sich über die linke und obere Schmalseite in Form von zwei Dreiecken weiterzieht. Die Rückseite trägt an der unteren linken Ecke eine Wort-Bild-Marke in Form eines Dreiecks, das sich über die linke und untere Schmalseite in Form von zwei Dreiecken weiterzieht.





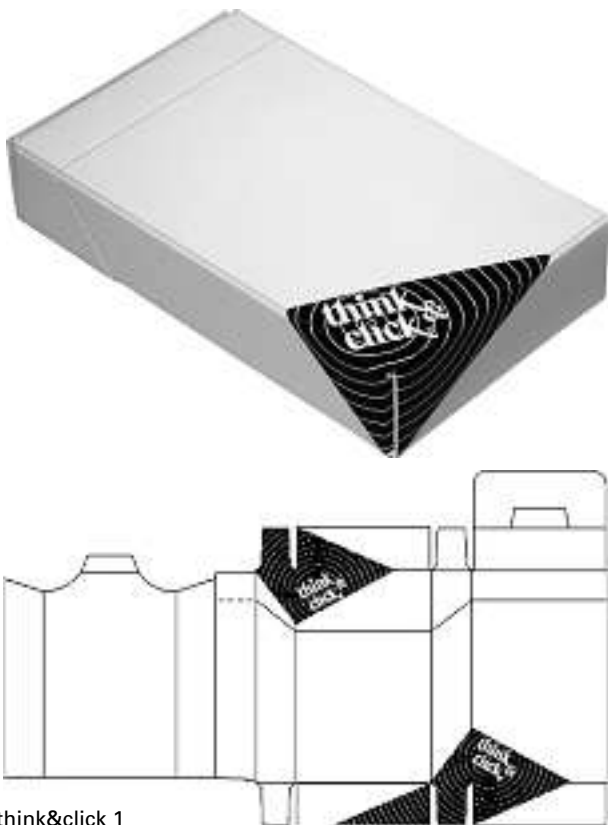

think&click 1

Cl. 03-01 134 706 17.01.2008  
 1 design – sac  
 Déposant: Marie-Josée Clamy Bocard, 60, rue des Lattes,  
 1217 Meyrin

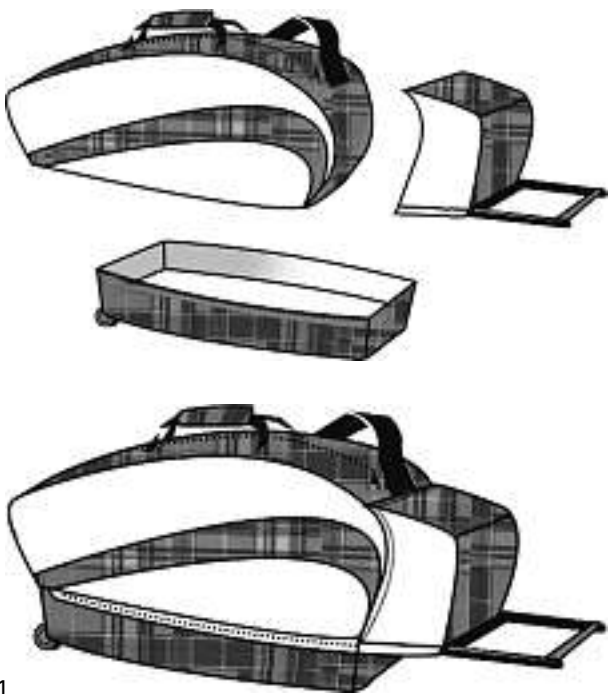

1

Cl. 04-02 134 707 23.01.2008  
 5 Design – Zahnbürstengriff  
 Hinterleger: Braun GmbH, Frankfurter Strasse 145,  
 61476 Kronberg, DE  
 Designer: Michaela Pusch, Usingen; Björn Kling, Glashütten;  
 Andreas Birk, Kronberg; Lucy Abigail Zimmermann,  
 Kronberg; Casey Gustafson, Iowa City; Todd Borgerson,  
 Mason  
 Vertreter: Servopatent GmbH, 8125 Zollikerberg  
 Priorität: US, 27.07.2007

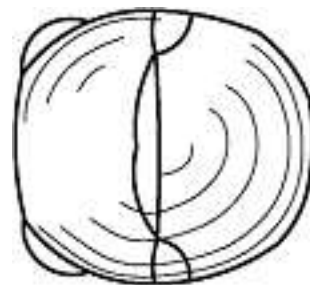
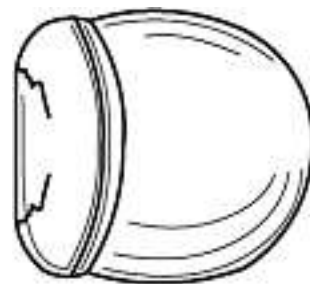
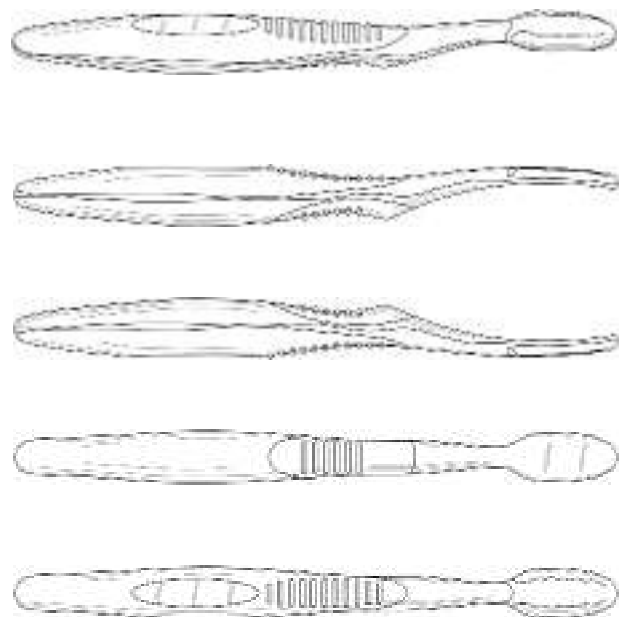

1

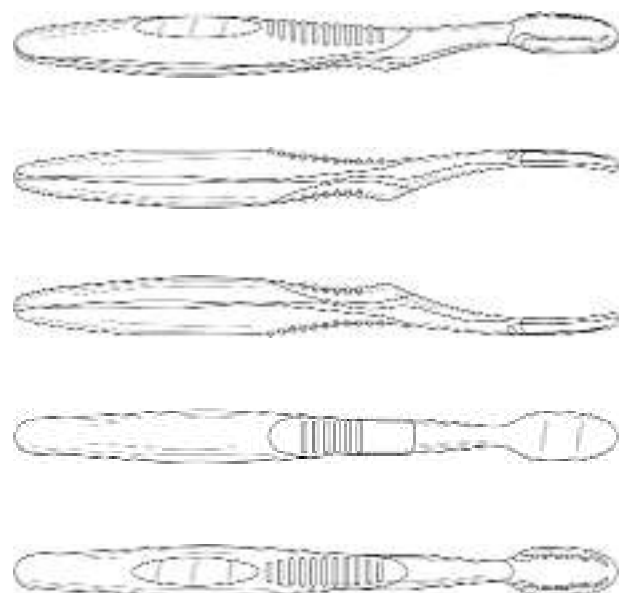

2

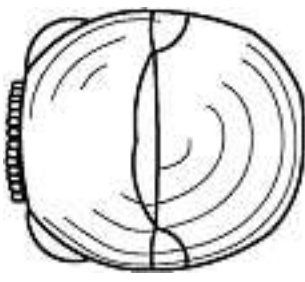
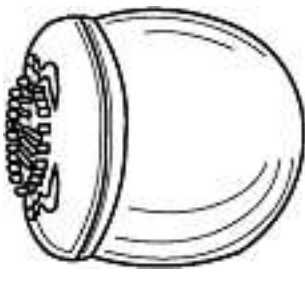
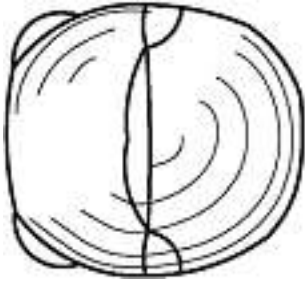
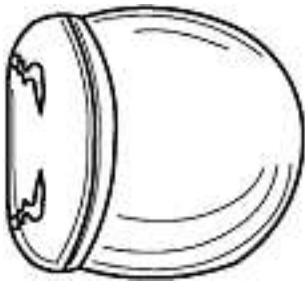

3

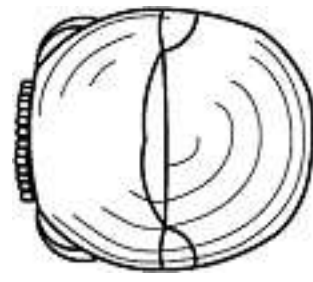

4



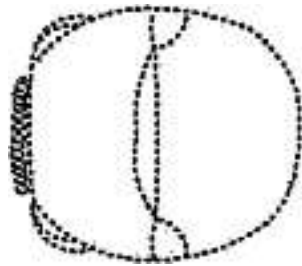
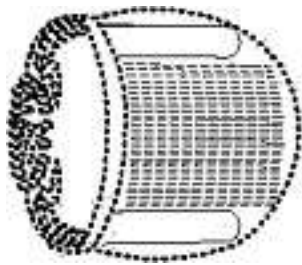
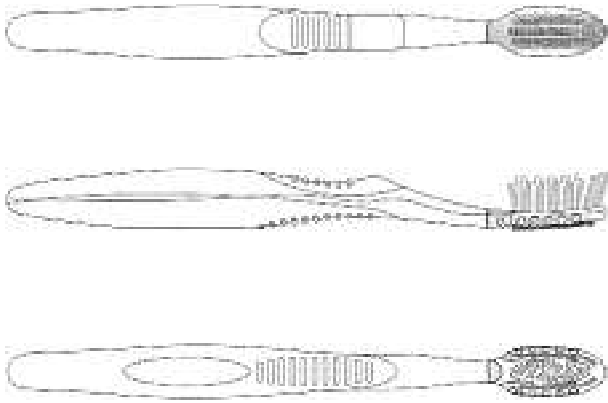

5

Cl. 05-05 **134 708** 22.01.2008  
 1 Design – Bemusterung für Textilien  
 Hinterleger: Oliver Huser, Höhenweg 562, 4717 Mümliswil

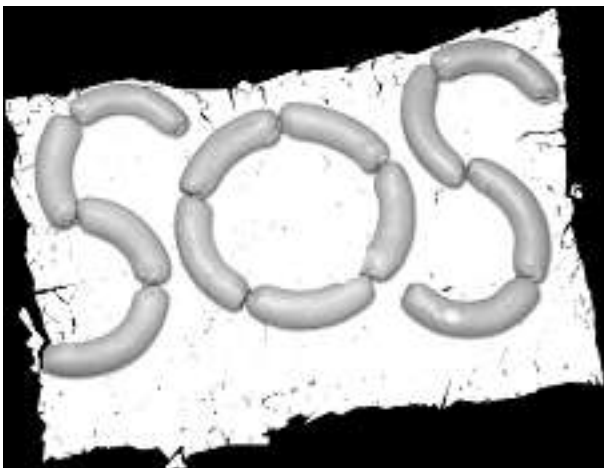

sos

Cl. 05-06 **134 709** 17.01.2008  
 1 design – papier toilette  
 Déposant: Georgia-Pacific France, 11, route Industrielle, 68320 Kunheim, FR  
 Designer: Donald Barredo, Ingersheim; Jean-Bernard Kuehn, Bennwihr  
 Mandataire: MICHELI & CIE SA, 1226 Thônex  
 Priorité: EM, 20.07.2007



15191A

Cl. 06-01, 06-02, 06-05 **134 710** 22.01.2008  
 7 Design – Sessel, Sofas, Hocker/Tisch, Bett  
 Hinterleger: Bise.com GmbH, Europa Center 13. OG, 10789 Berlin, DE  
 Designer: Giuseppe Vigano, Lissone  
 Vertreter: Wartmann & Merker, 8022 Zürich  
 Priorität: EM, 02.08.2007





States-Sessel-XL



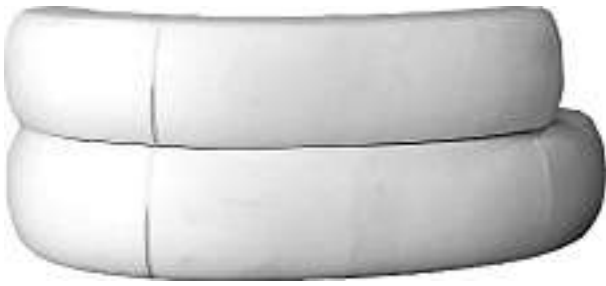

States-Sofa-klein



States-Sofa-mittel



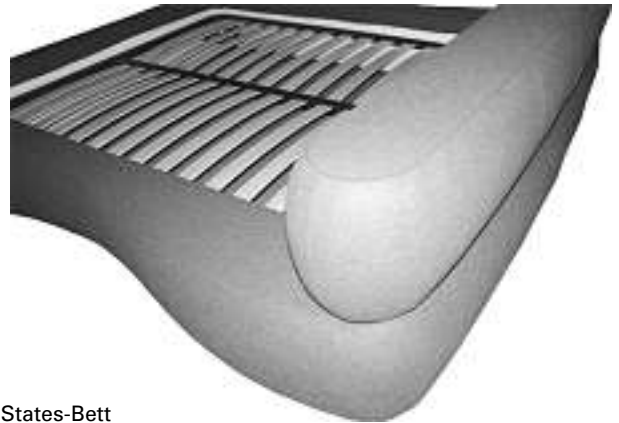

States-Bett





States-Dormeuse

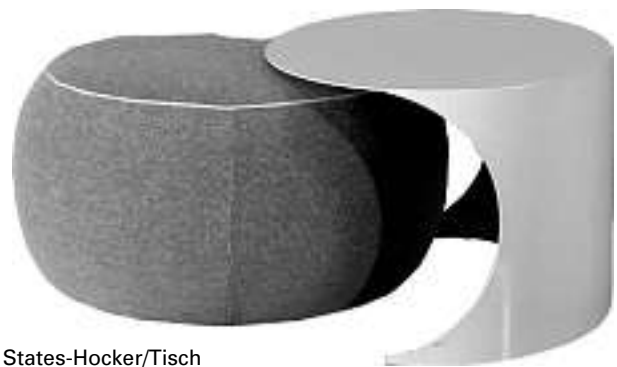

States-Hocker/Tisch



States-Dormeuse mit Hocker/Tisch

Cl. 06-03 134 711 15.01.2008  
 2 design – table  
 Déposant: Laetitia Voirol, Rue de Boujean 161, 2504 Bienne



up



crouch

Cl. 06-06 134 712 22.01.2008  
 4 Design – Raumteiler  
 Hinterleger: Rolf Benz AG & Co. KG, Haiterbacher Strasse 104, 72202 Nagold, DE  
 Designer: Sebastian Labs, Nagold; Nadine Müller, Nagold; Mario Sasse, Nagold  
 Vertreter: Bovard AG, 3000 Bern 25  
 Priorität: EM, 17.09.2007; EM, 17.09.2007; EM, 17.09.2007; EM, 17.09.2007

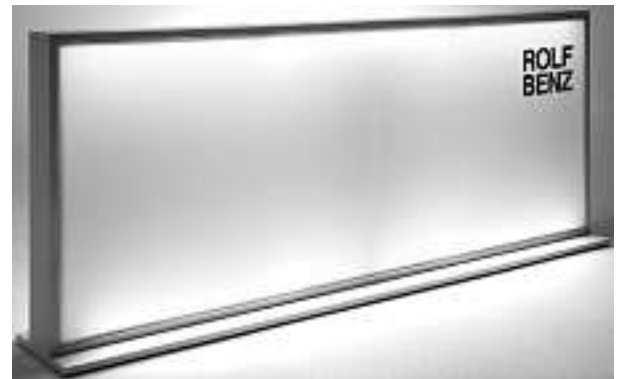
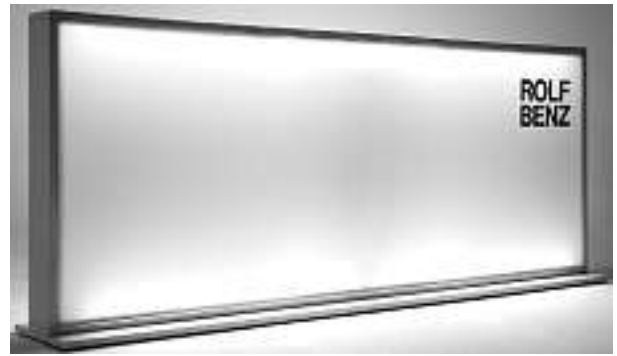

300641-1

300641-2



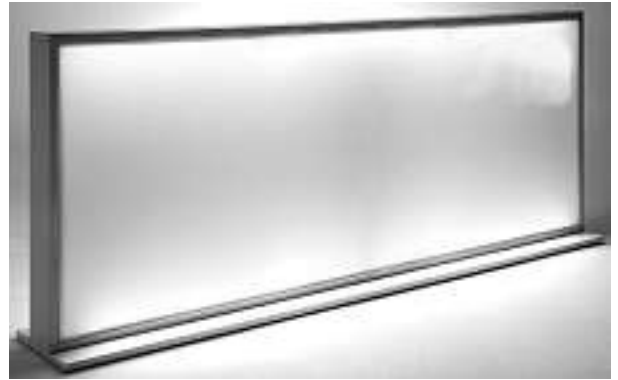
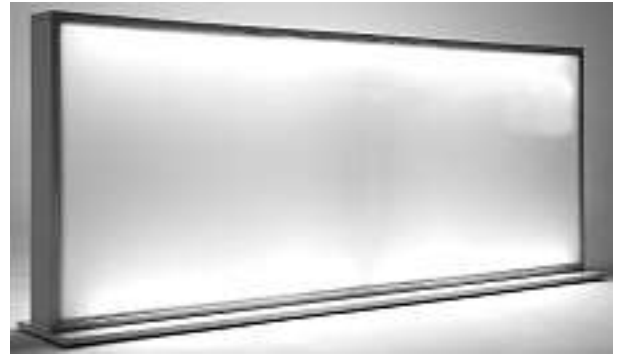

300641-4



300641-3

Cl. 07-02 134 713 11.01.2008  
1 Design – Caquelon  
Hinterleger: Michael Steinlin, Alte Speicherstrasse 2615,  
9053 Teufen AR





CA1

Cl. 07-06                      **134 715**                      21.12.2007  
 1 design – support pour ustensiles de cuisine  
 Déposant: Pierre-Alain Urfer, Chemin du Château 3,  
 1443 Champvent; Paul-Marie Buhler, Chemin de la  
 Musardière 11, 1131 Tolochennaz  
 Mandataire: Lemman Consulting S.A., 1260 Nyon



1

Cl. 07-06                      **134 716**                      23.01.2008  
 1 Design – Gewürzstreuer  
 Hinterleger: Peter Meyer, Chamerstrasse 44, 6300 Zug  
 Vertreter: Industrieberatung Maier AG, 4450 Sissach





1

Cl. 08-05                      134 717                      16.01.2008

1 Design – Zangenkopf  
 Hinterleger: TOPICO Handels-GmbH & Co. KG,  
 Süderstrasse 259, 20537 Hamburg, DE  
 Designer: Wing Hang Fung, Yangjian  
 Vertreter: Isler & Pedrazzini AG, 8027 Zürich  
 Priorität: EM, 17.07.2007

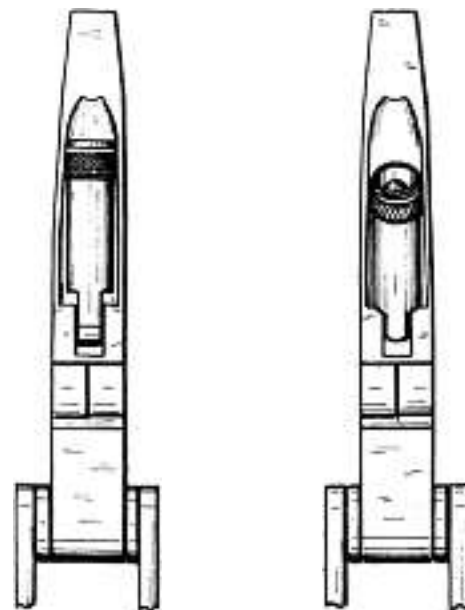
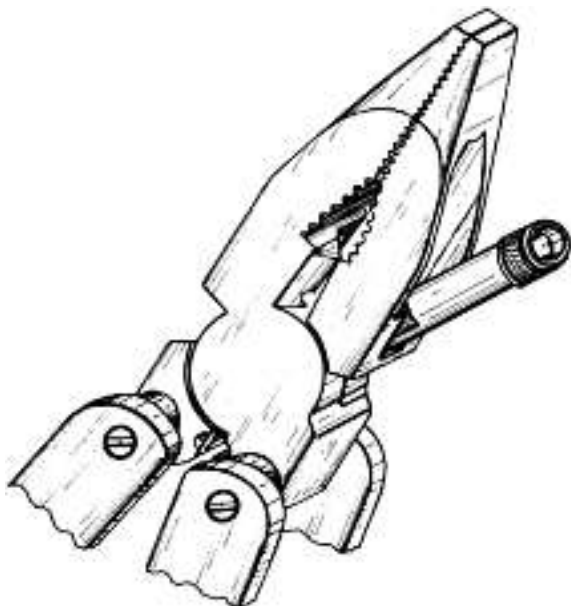
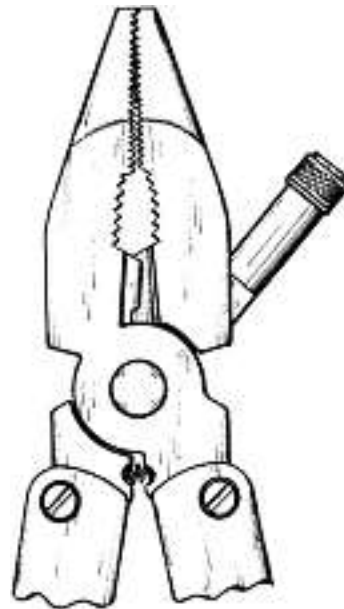
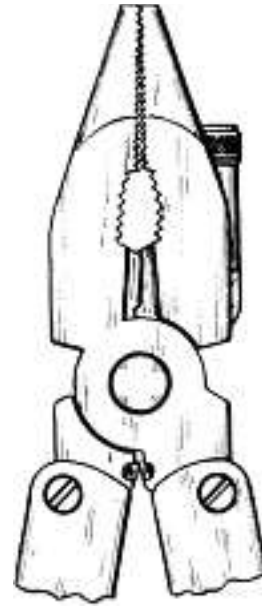

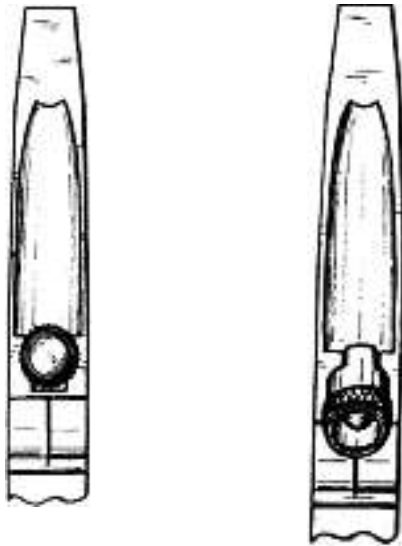

M13459



Cl. 08-08                      **134 718**                      21.01.2008  
1 Design – Rohrverschraubung  
Hinterleger: KULM Holding AG, Schützenstrasse 25,  
8355 Aadorf  
Designer: Christoph Bachmann, Rickenbach  
Vertreter: Georg Fischer AG, 8201 Schaffhausen

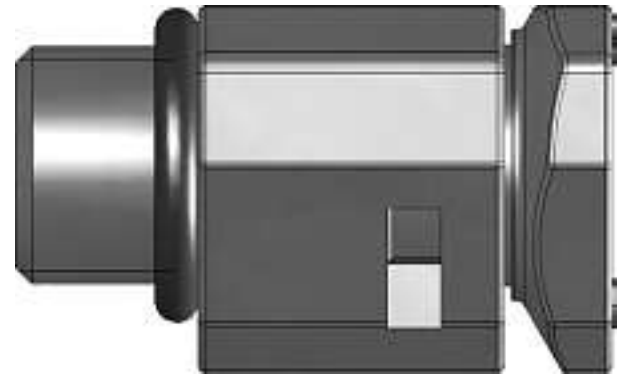



0344/SER CH

Cl. 09-01 **134 719** 21.01.2008  
 1 Design – Teil einer Flasche  
 Hinterleger: Oy Sinebrychoff Ab, Sinebrychoffinaukio 1,  
 04250 Kerava, FI  
 Designer: Rami Toivonen, Lahti  
 Vertreter: A.W. Metz & Co. AG, 8024 Zürich  
 Priorität: FI, 13.08.2007

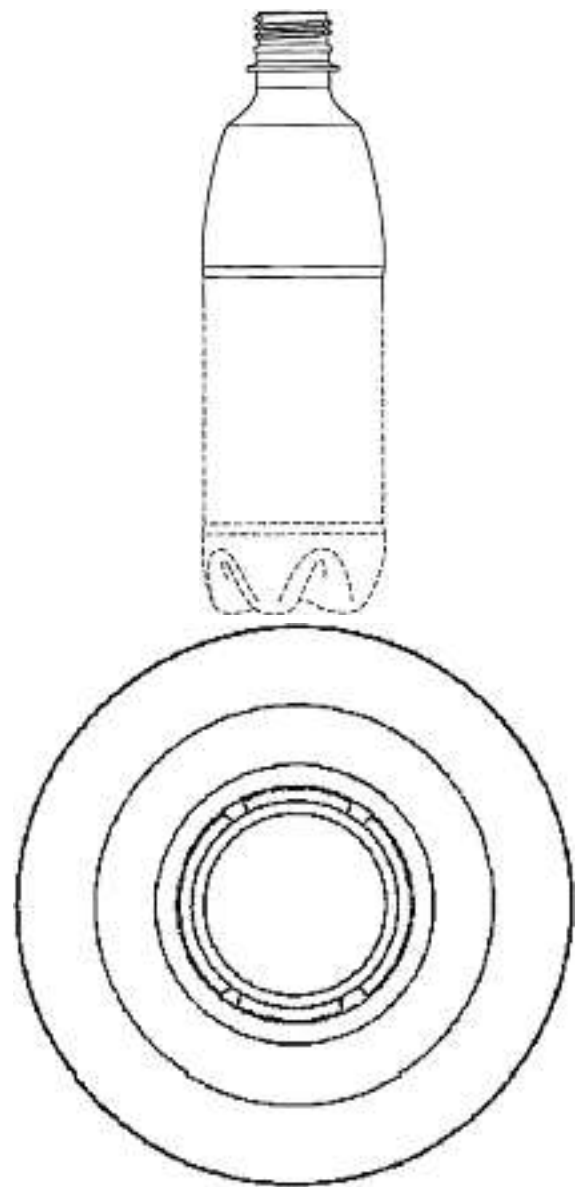

1

Cl. 09-01 **134 720** 21.01.2008  
 1 Design – Teil einer Flasche  
 Hinterleger: Oy Sinebrychoff Ab, Sinebrychoffinaukio 1,  
 04250 Kerava, FI  
 Designer: Rami Toivonen, Lahti  
 Vertreter: A.W. Metz & Co. AG, 8024 Zürich  
 Priorität: FI, 17.08.2007

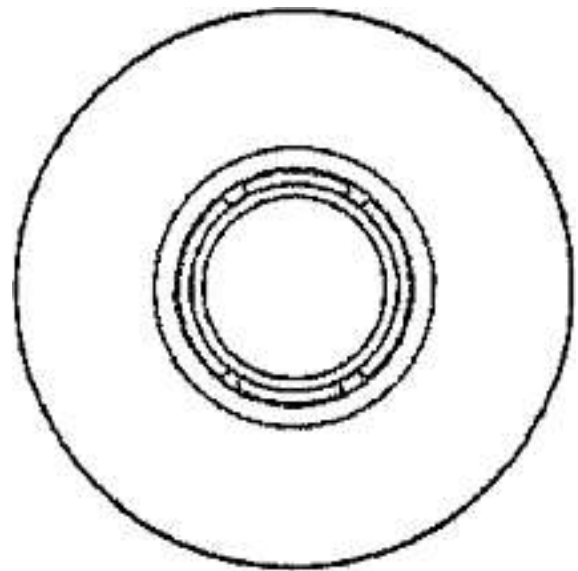



1

Cl. 09-03 134 721 03.01.2008  
4 Design – Dosen  
Hinterleger: Grether AG, Parkstrasse 5, 4102 Binningen  
Designer: Artur Wichowski, Thun  
Vertreter: lic. iur. Klaus Feger, Advokat, 4010 Basel



590-1374B





590-1376B



590-1380B



590-1378B

Cl. 09-03 134 722 21.01.2008  
1 Design – Dose  
Hinterleger: Flaigg AG, Langenhagstrasse 3, 4147 Aesch BL  
Designer: Sören Wulf, Königstein

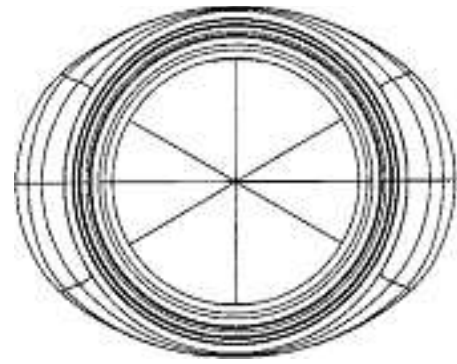

4078

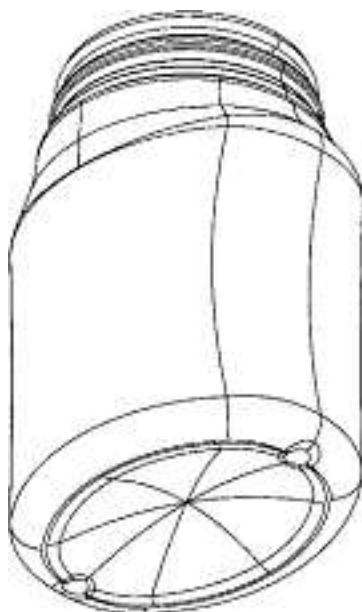
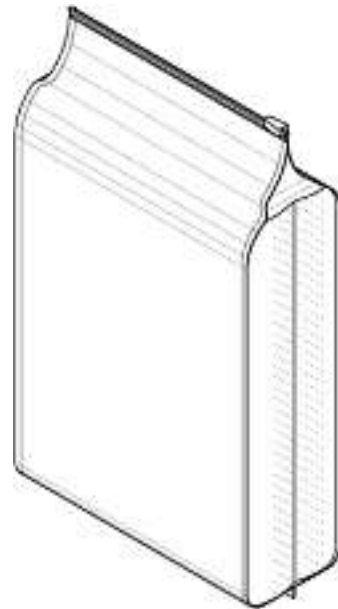
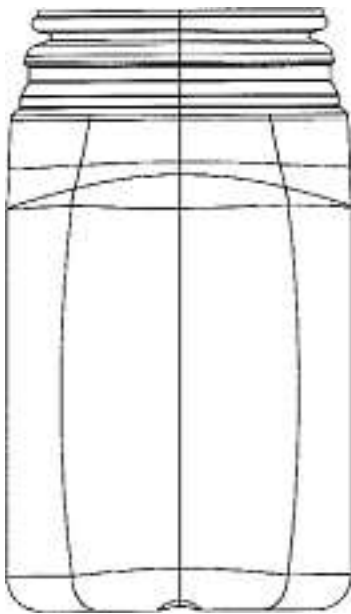

Cl. 09-05 **134 723** 23.01.2008

4 Design – Beutel

Hinterleger: The Iams Company, 7250 Poe Avenue,  
Dayton (OH 45414), US

Designer: George Scott Kerr, Mason; Lawrence Andrew  
Schumacher, Trenton; Barry Stanley Shantz, Cincinnati

Vertreter: Servopatent GmbH, 8125 Zollikerberg  
Priorität: US, 02.08.2007; US, 02.08.2007



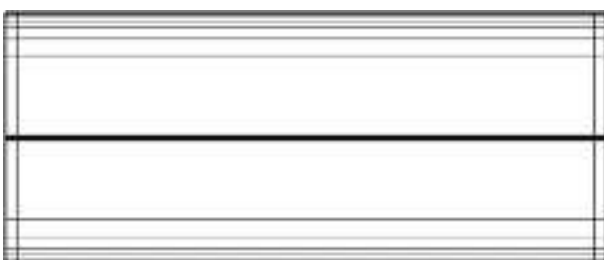
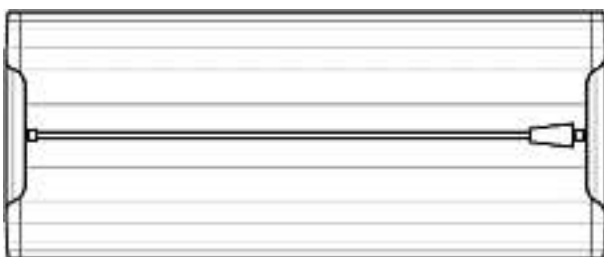
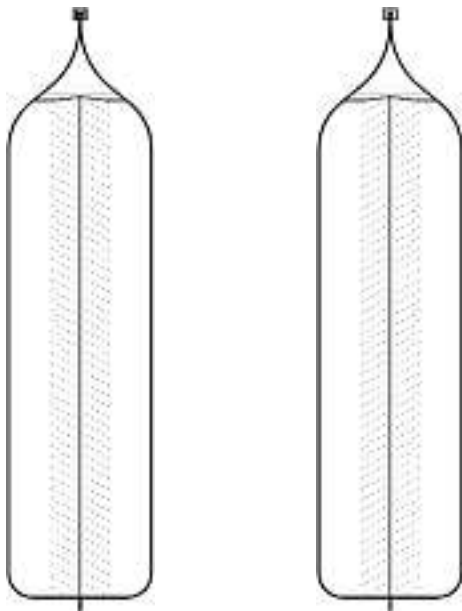
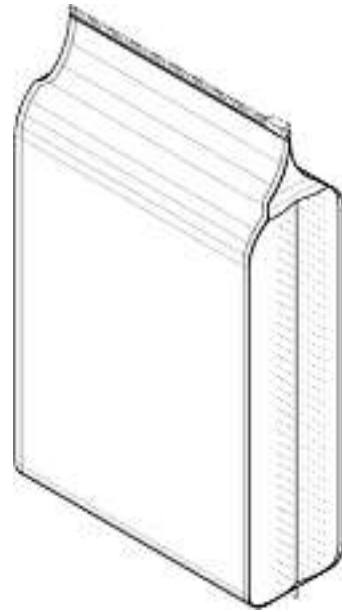

1



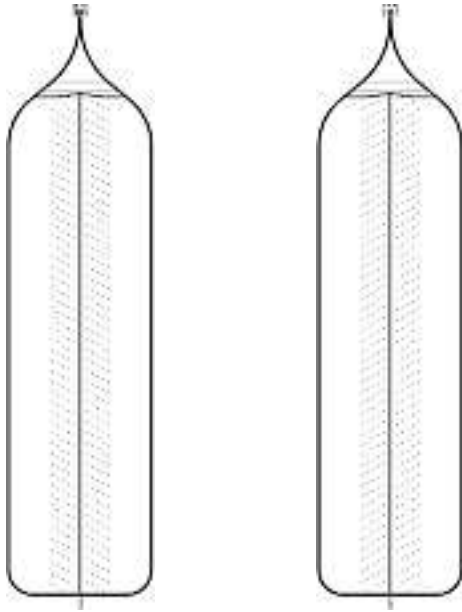

2

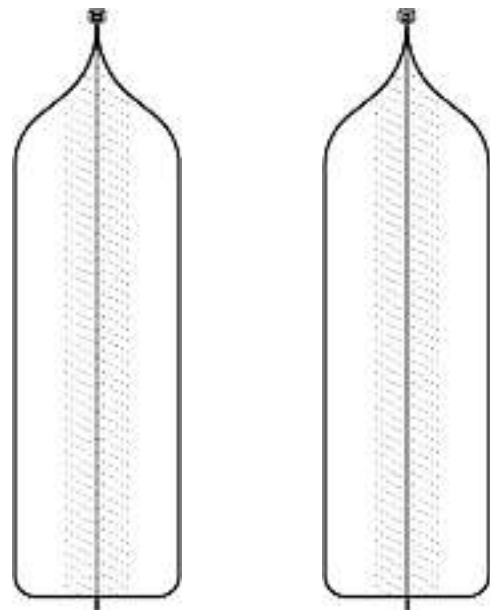
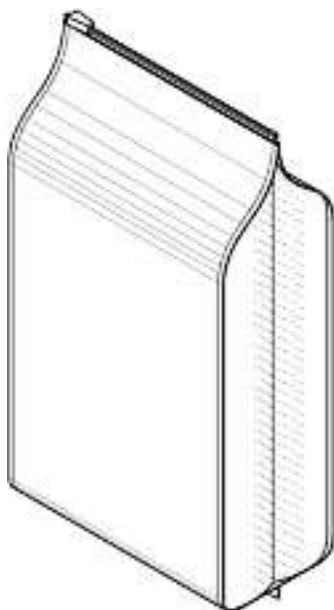

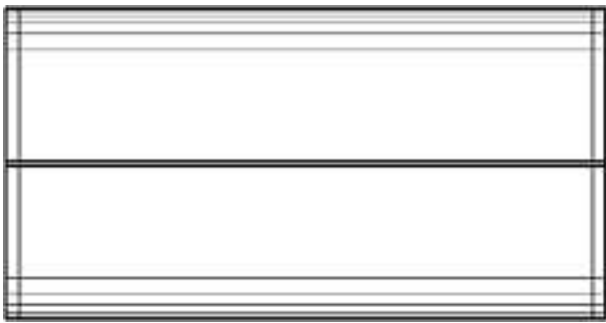
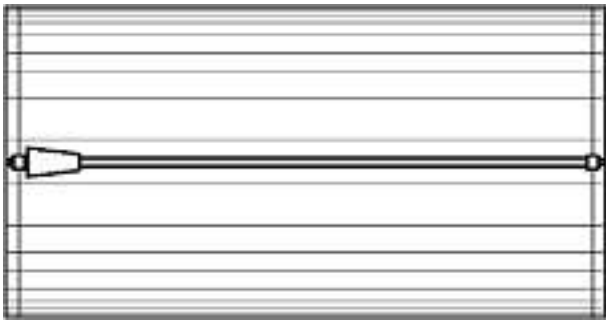

3

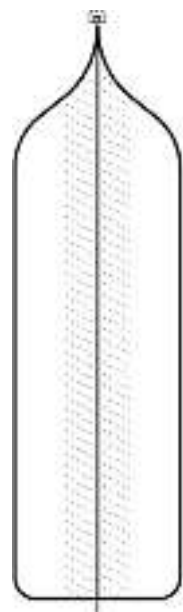
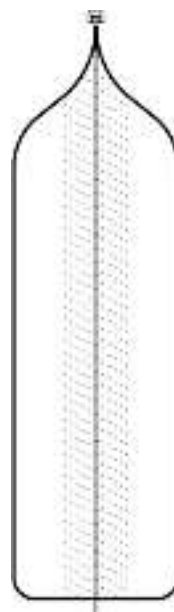
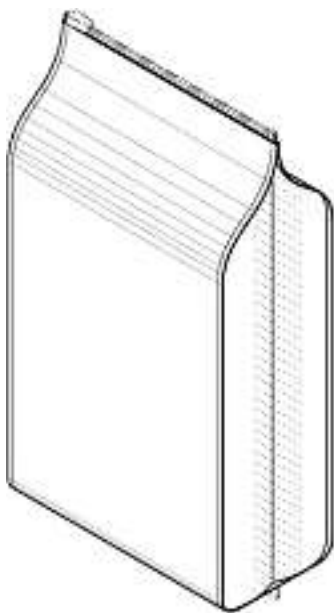



4

Cl. 10-02 134 724 21.12.2007  
 1 design – montre-bracelet  
 Déposant: CSDconsulting Sàrl, Rue du Borgeaud 12,  
 1196 Gland  
 Designer: Eddy Burgener, Le Landeron



B01R

Cl. 10-02 134 725 27.12.2007  
 1 design – montre-bracelet  
 Déposant: CSDconsulting Sàrl, Rue du Borgeaud 12,  
 1196 Gland  
 Designer: Eddy Burgener, Le Landeron



B01RL

Cl. 10-02, 10-07 134 726 14.01.2008  
 29 Design – Uhrengehäuse, Uhrenarmbänder, Zifferblätter,  
 Armbanduhren  
 Hinterleger: FESTINA LOTUS, S.A., Via Layetana, 20-4a,  
 08003 Barcelona, ES  
 Designer: Miguel Rodriguez, Barcelona  
 Vertreter: Isler & Pedrazzini AG, 8027 Zürich  
 Priorität: EM, 13.07.2007

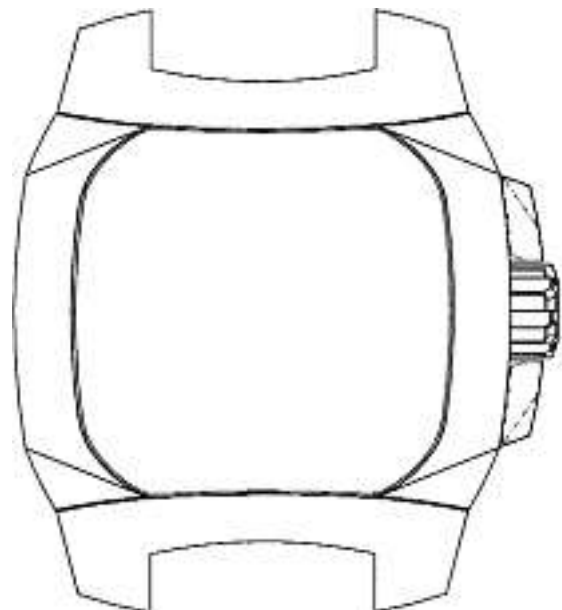
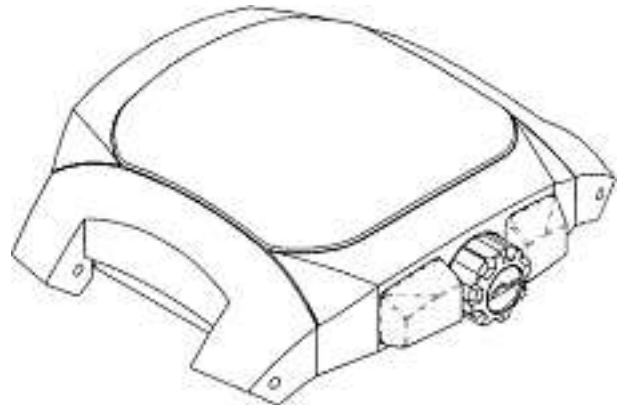

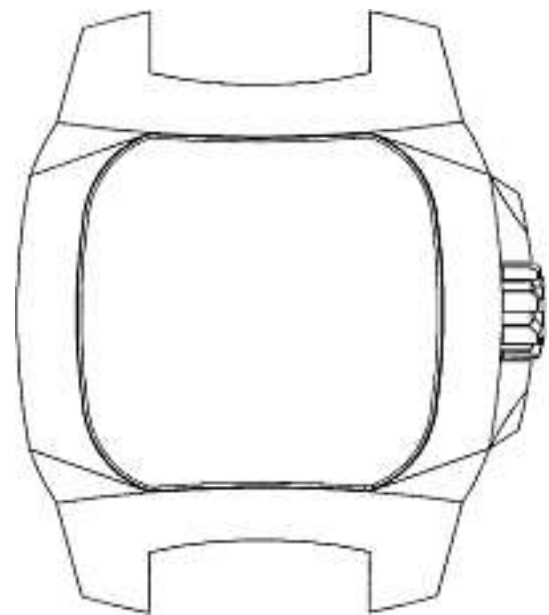
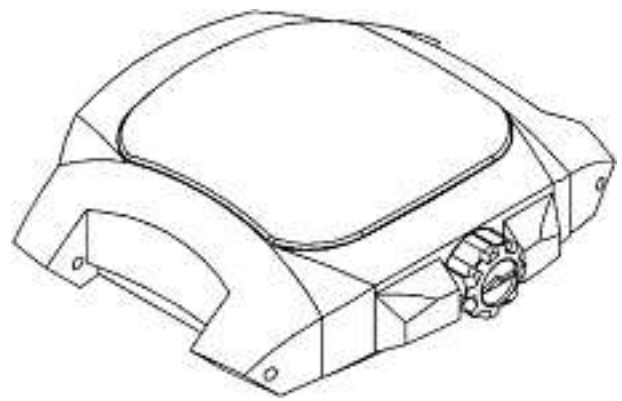
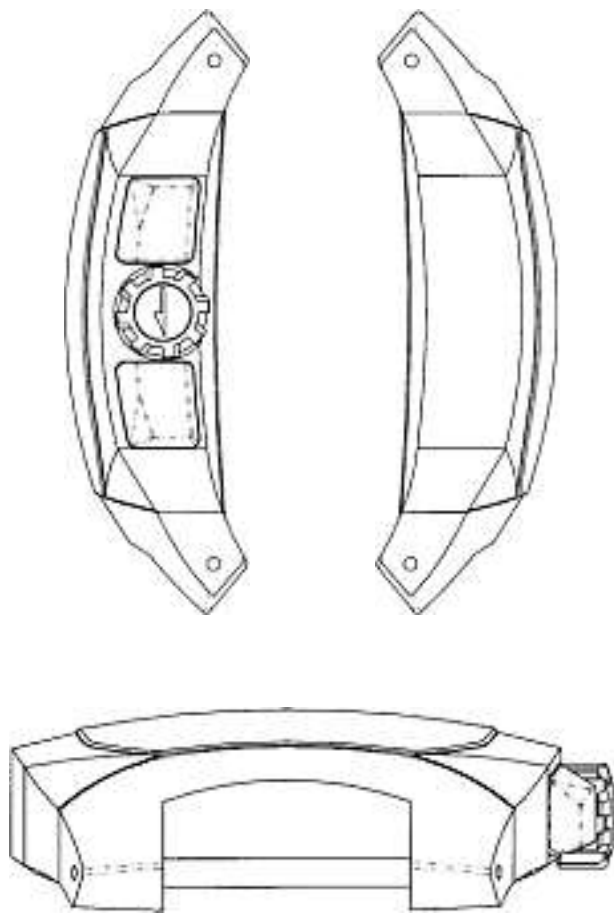

M13458-01

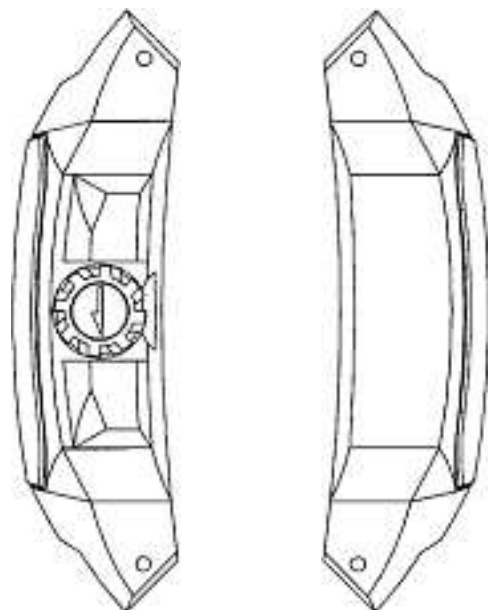
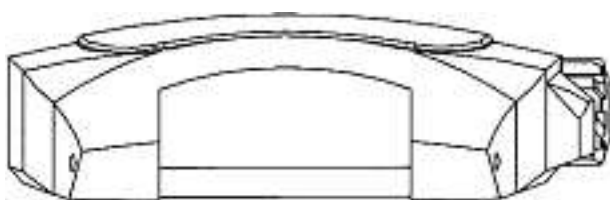



M13458-02

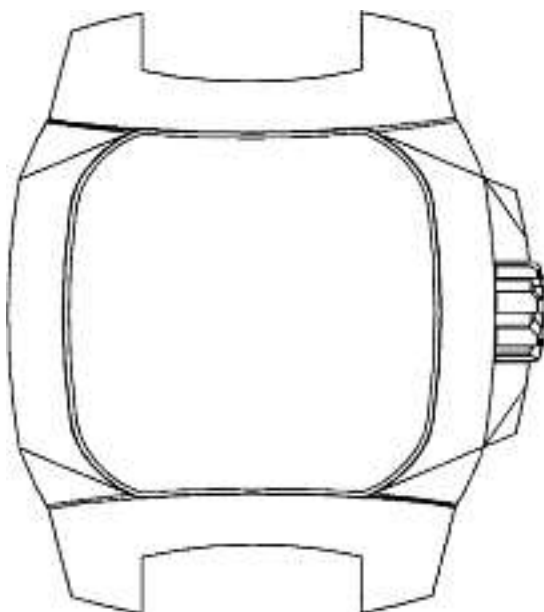
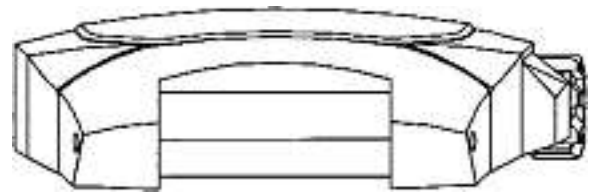
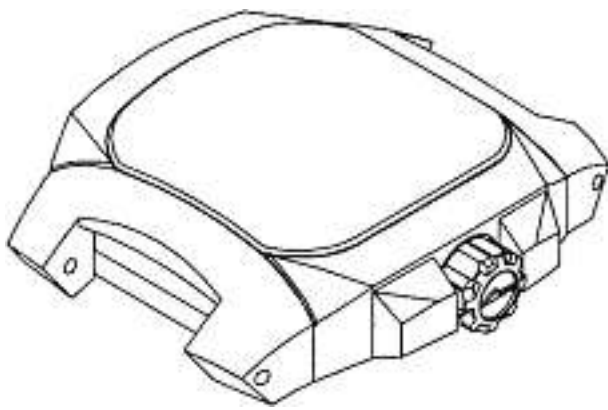
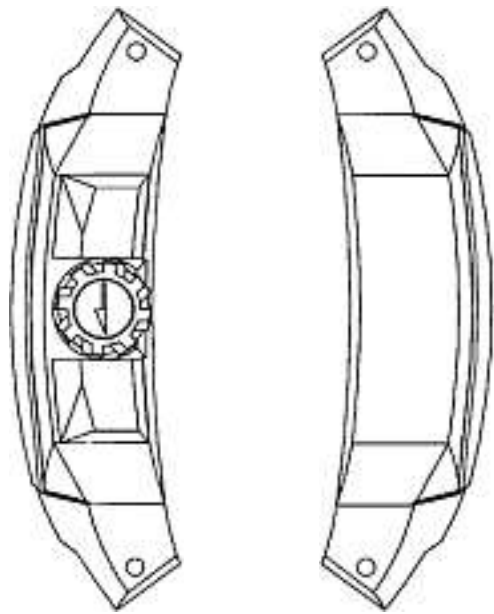

M13458-03

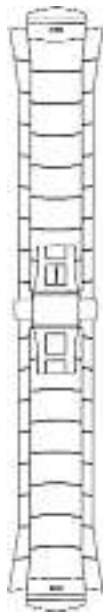
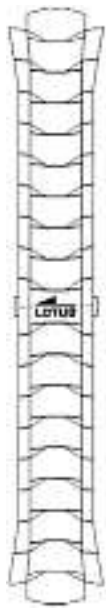

M13458-04

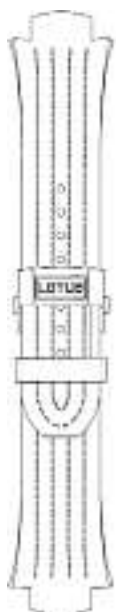

M13458-05



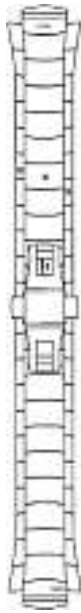
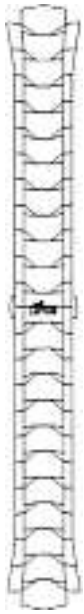

M13458-07

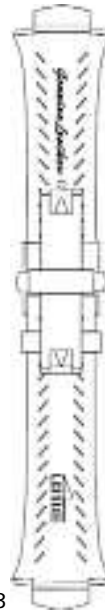
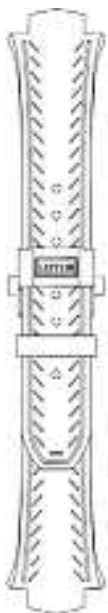

M13458-08



M13458-09



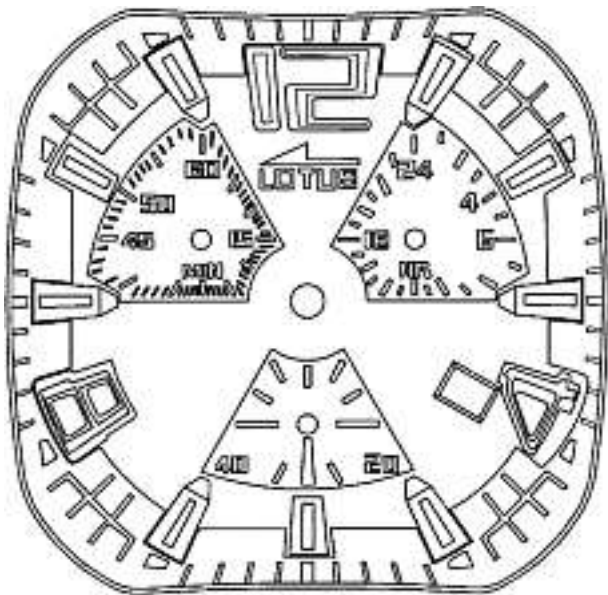

M13458-10

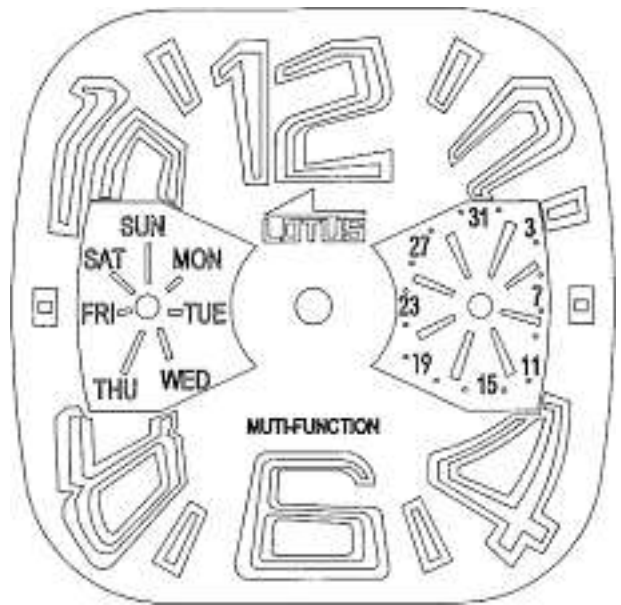

M13458-13

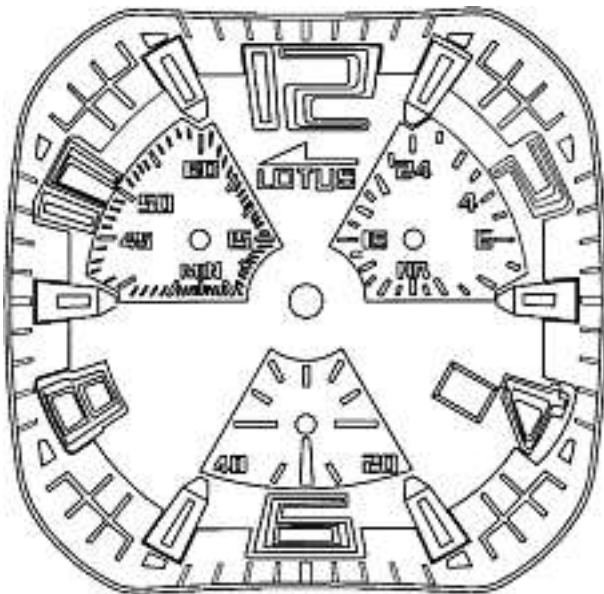

M13458-11



M13458-14

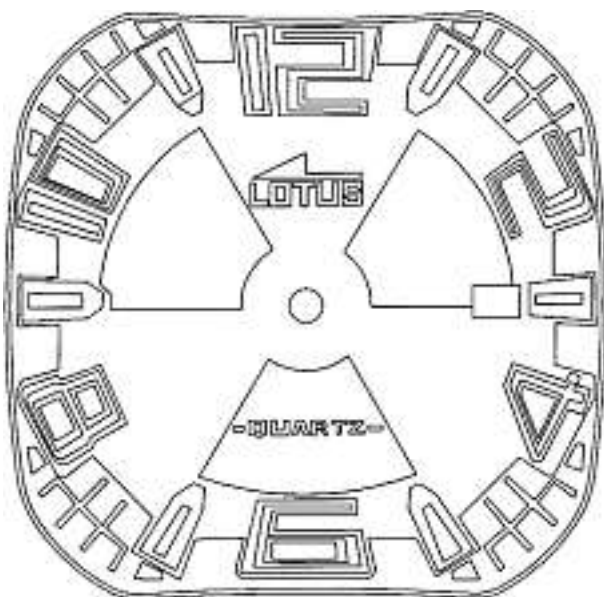

M13458-12

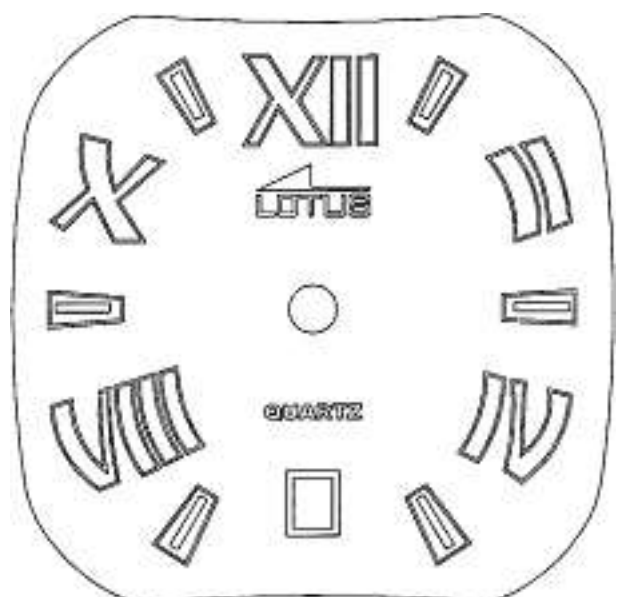

M13458-15

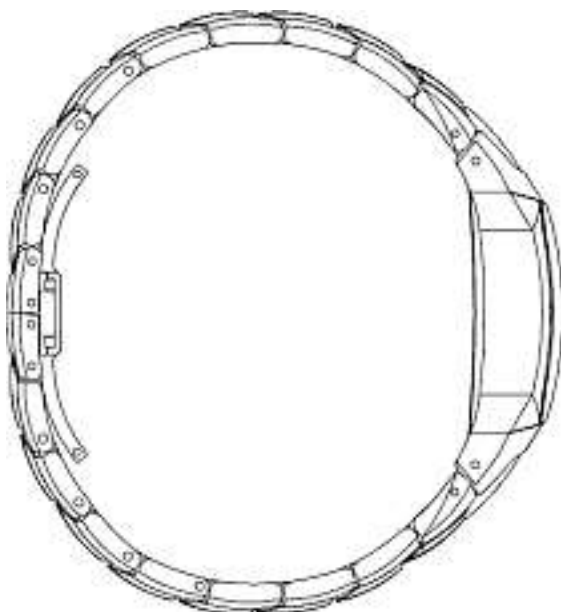
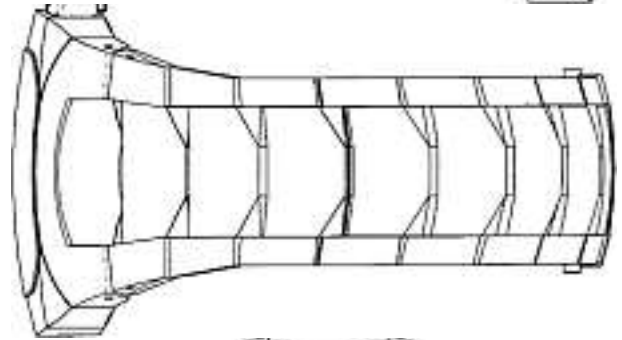
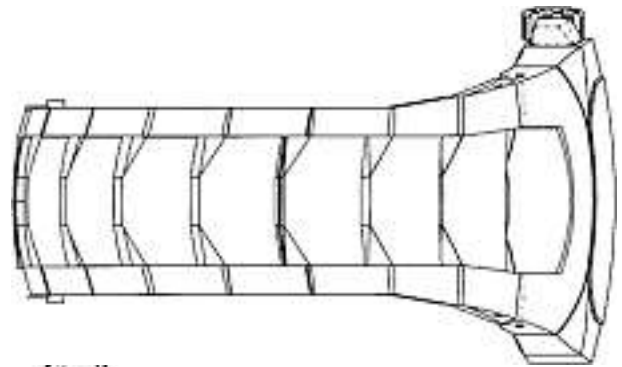

M13458-16

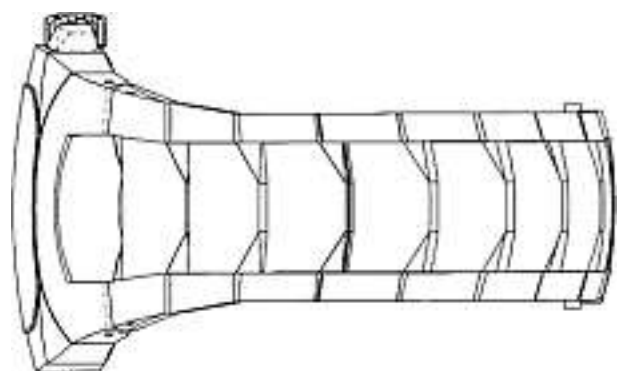
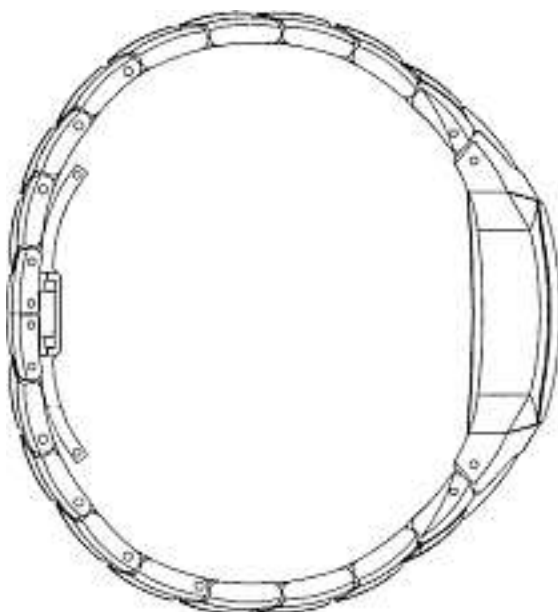
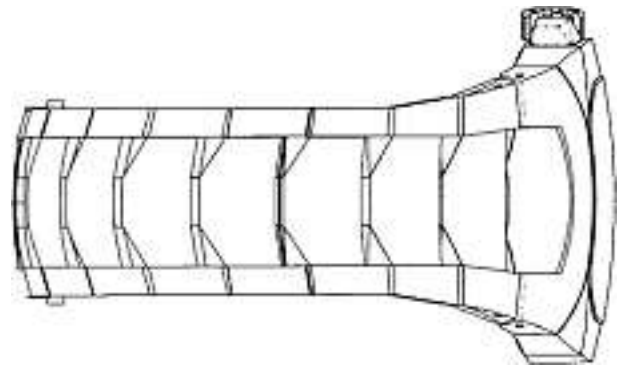

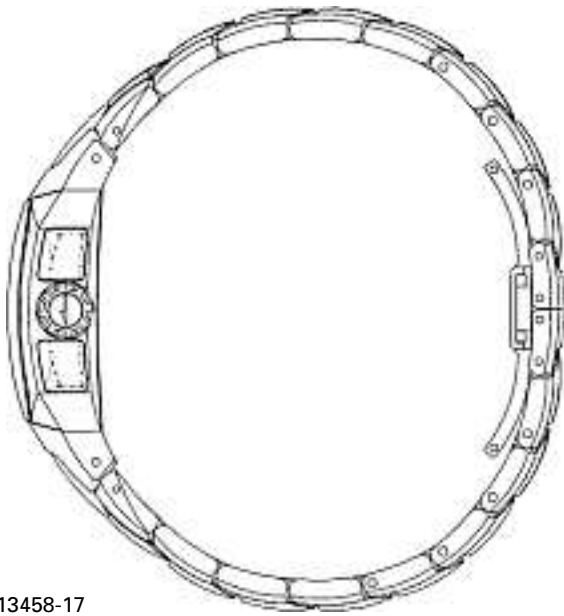

M13458-17

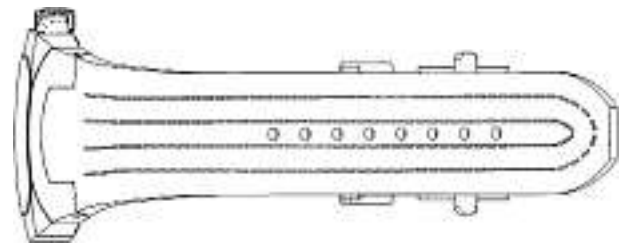
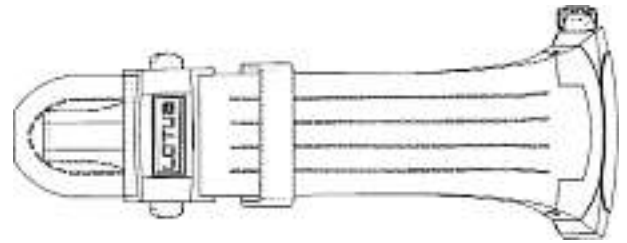



M13458-18

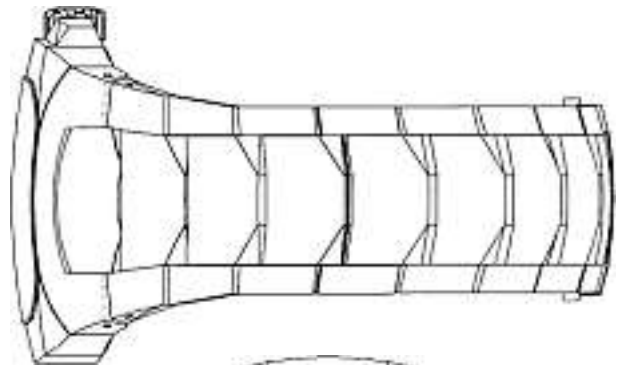
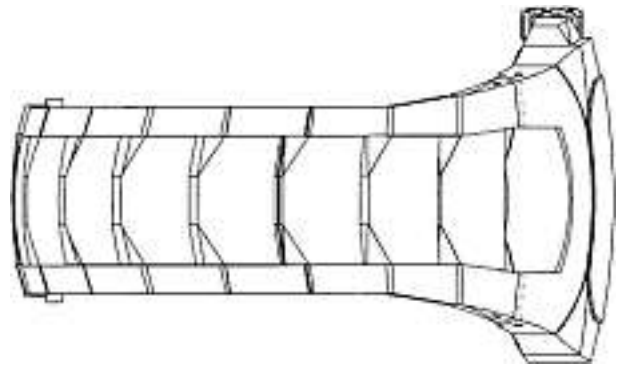
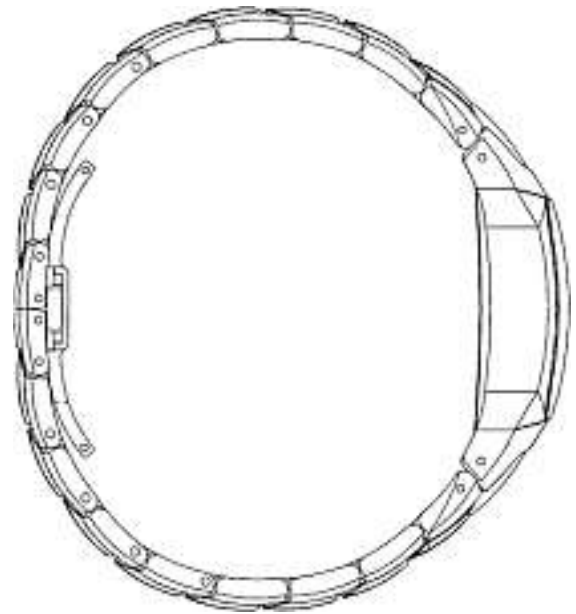

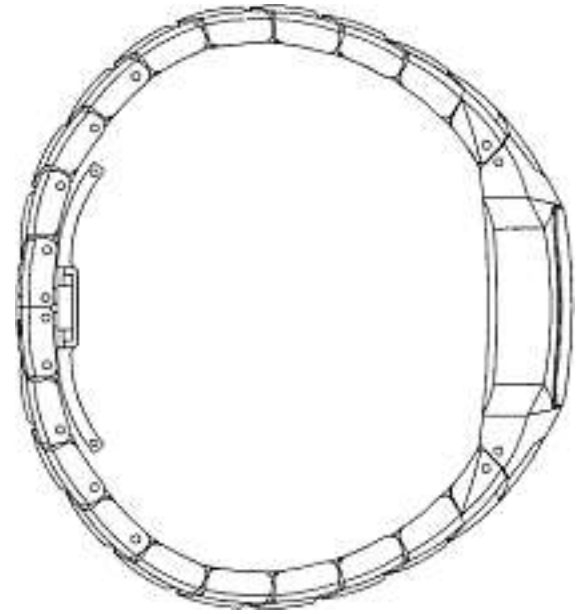
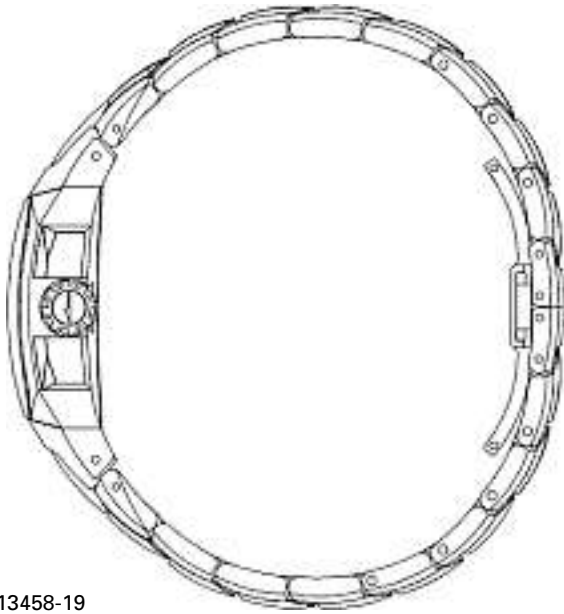

M13458-19

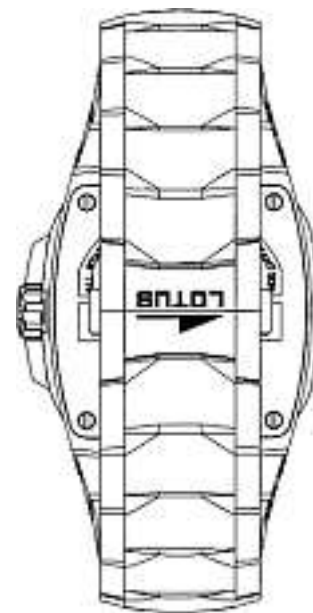
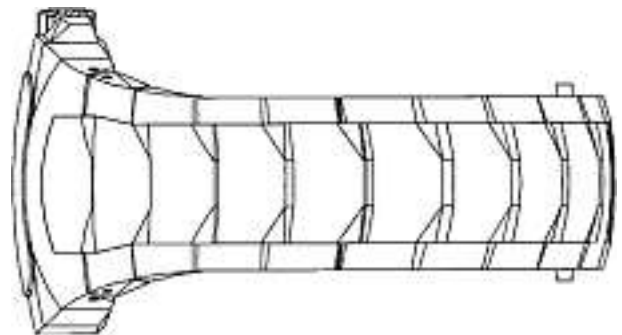
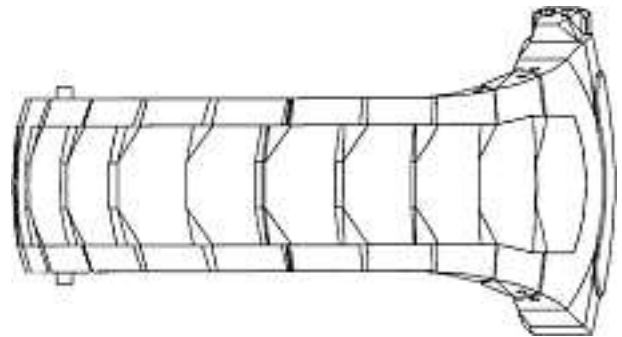

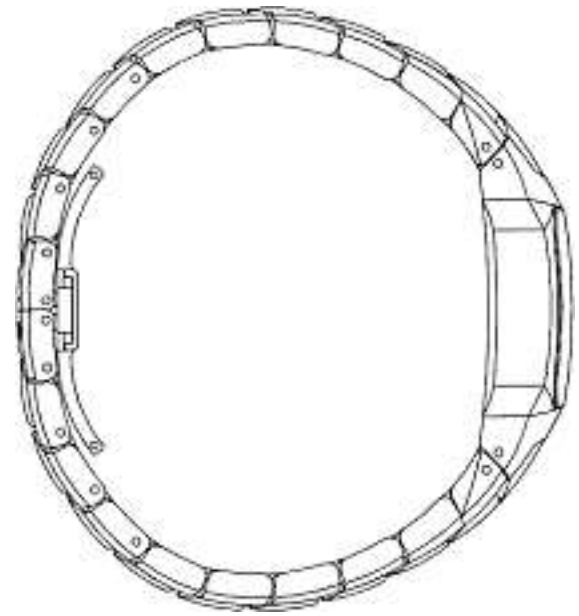

M13458-20

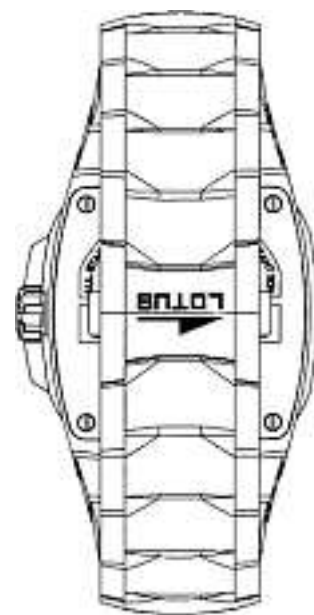
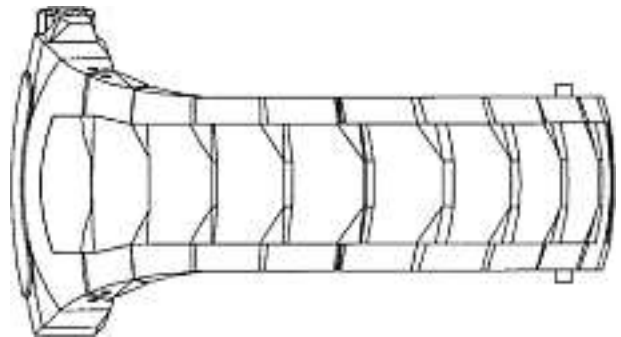
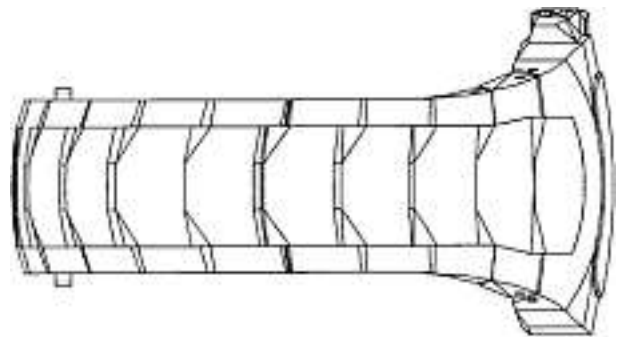

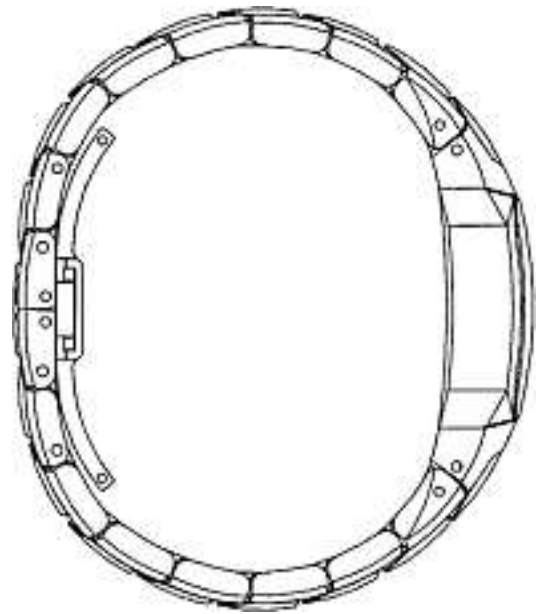
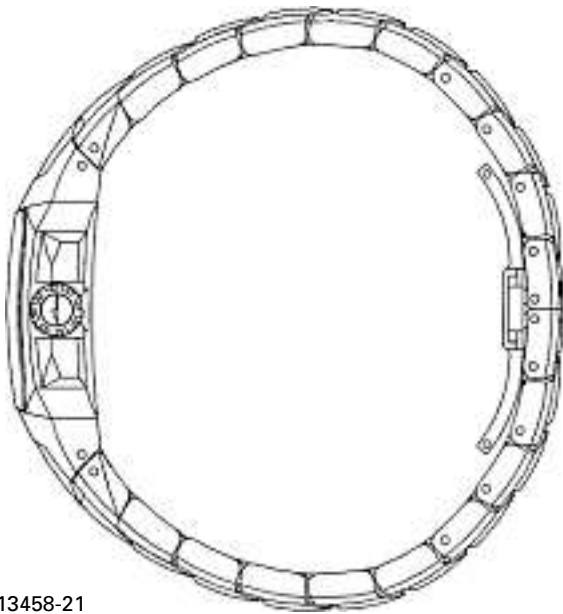

M13458-21

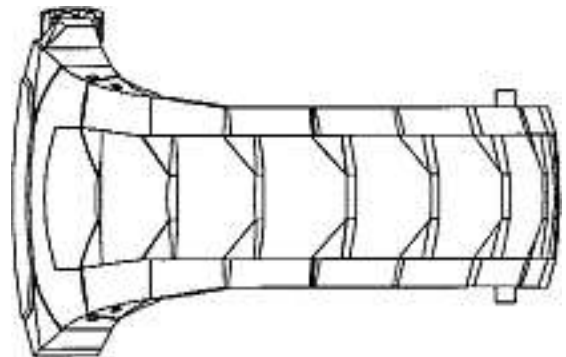
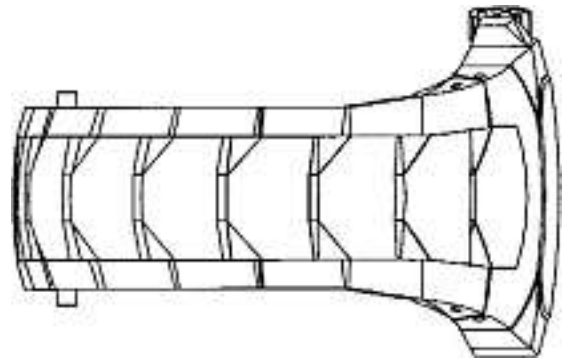



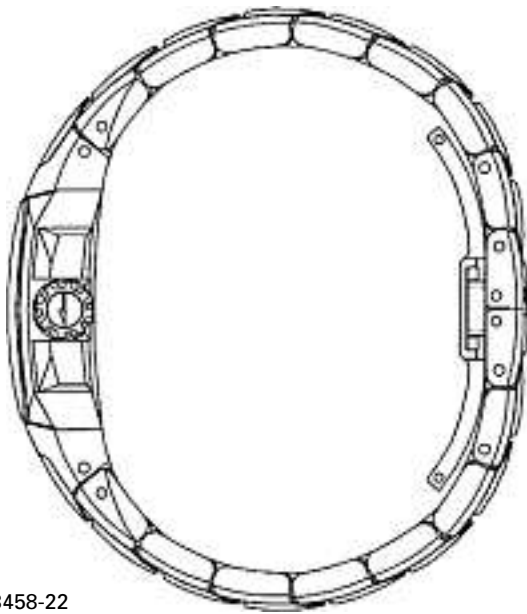

M13458-22

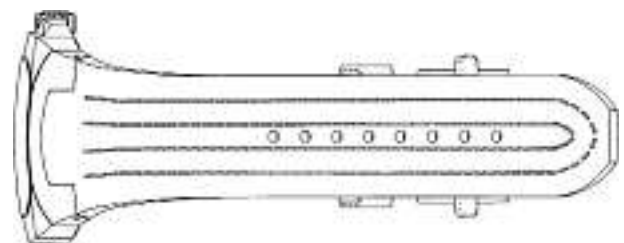
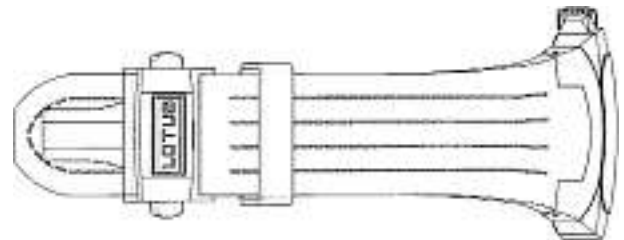
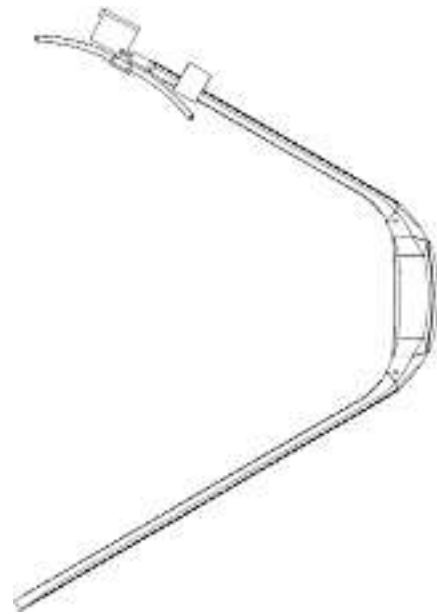

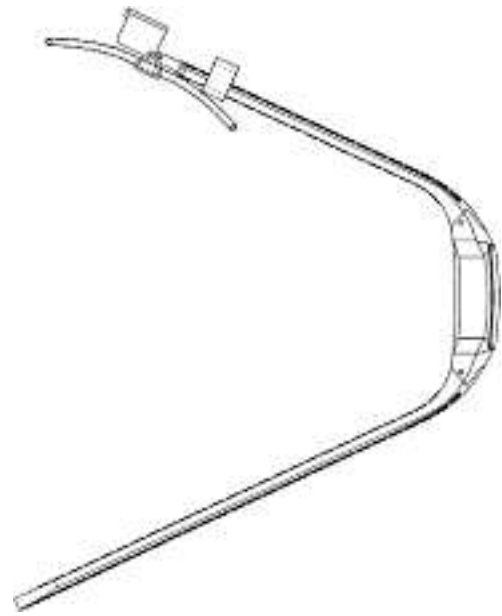
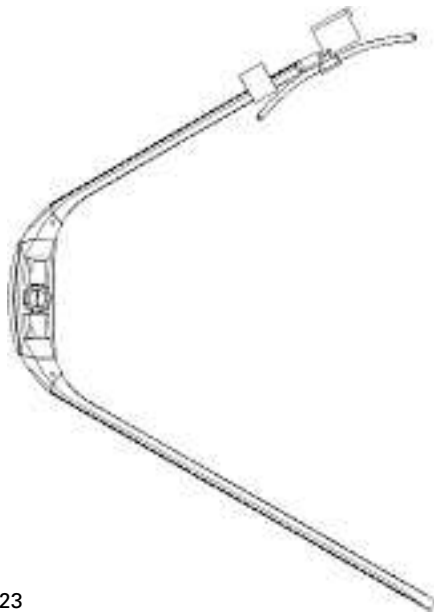

M13458-23

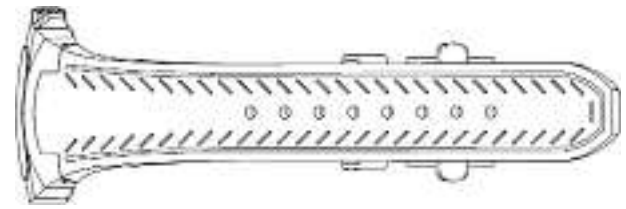
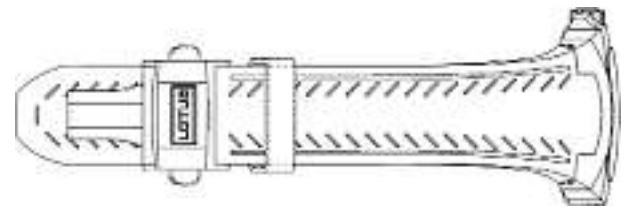

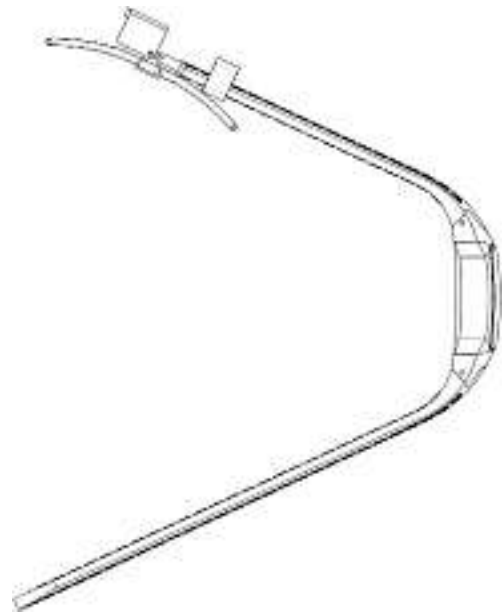
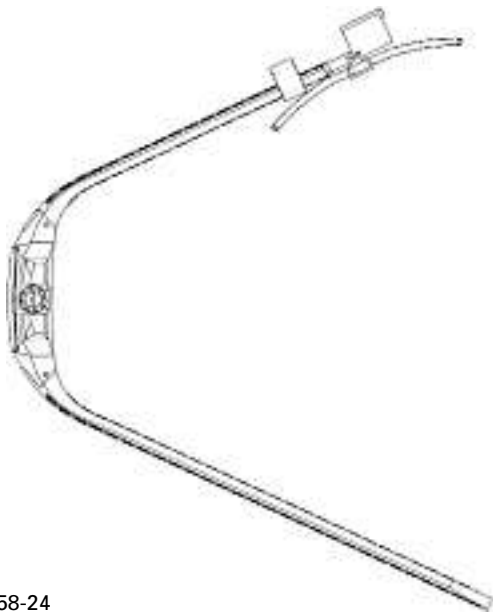

M13458-24

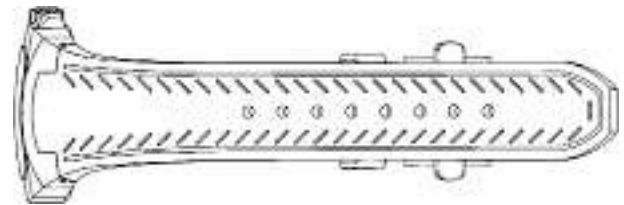
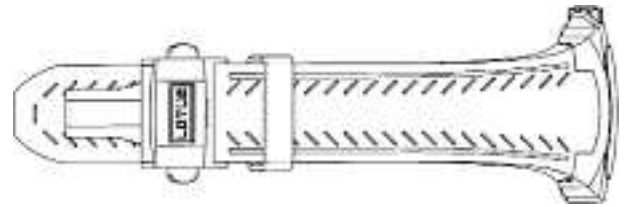

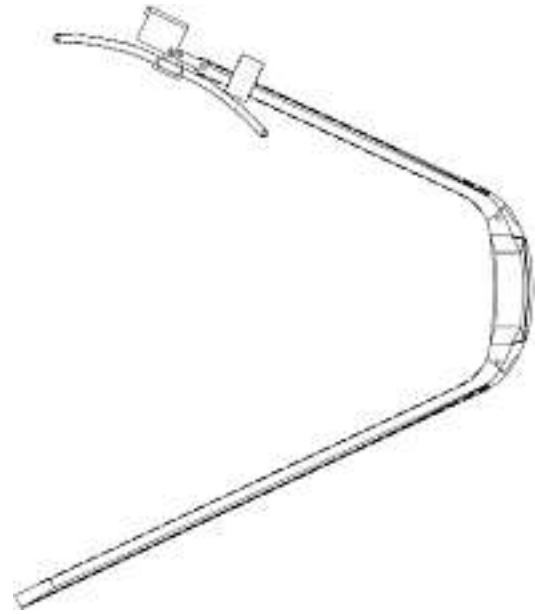
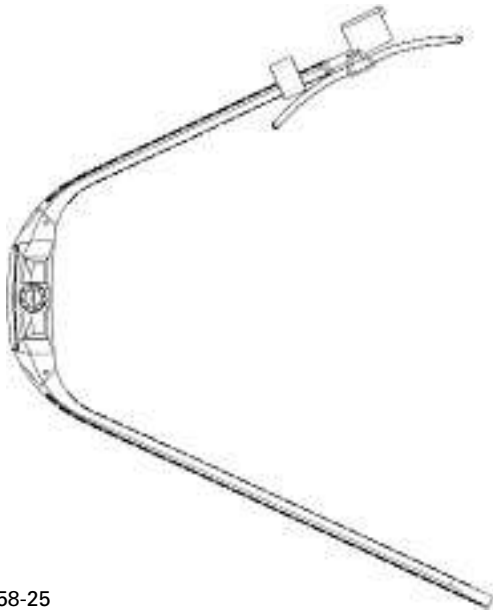

M13458-25

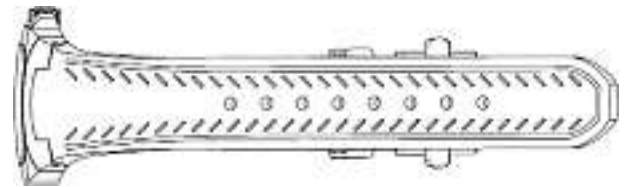
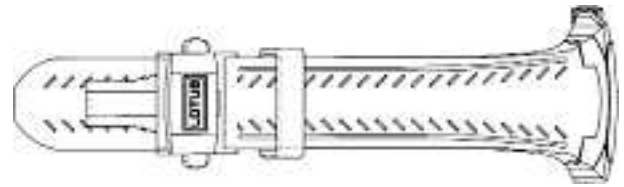

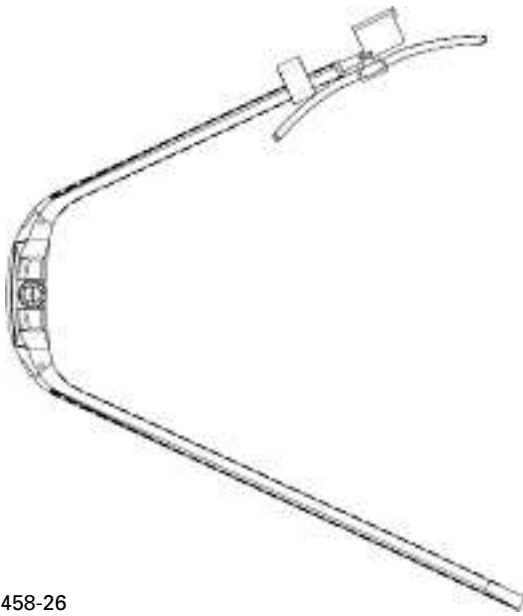

M13458-26

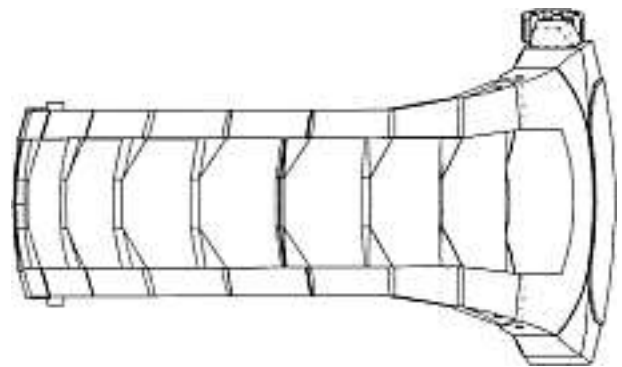
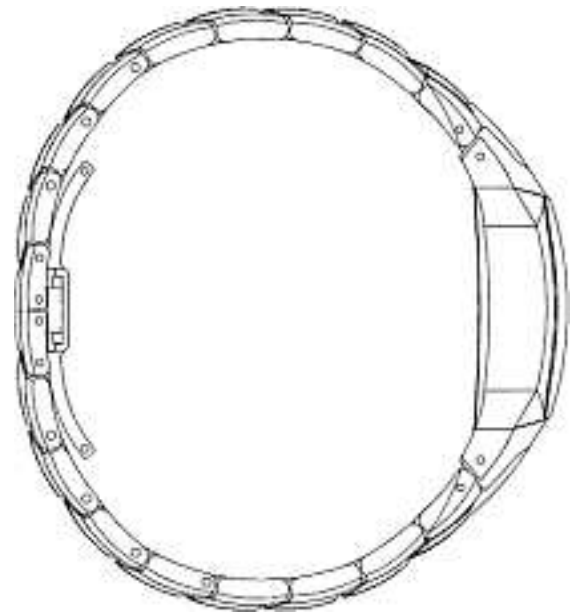

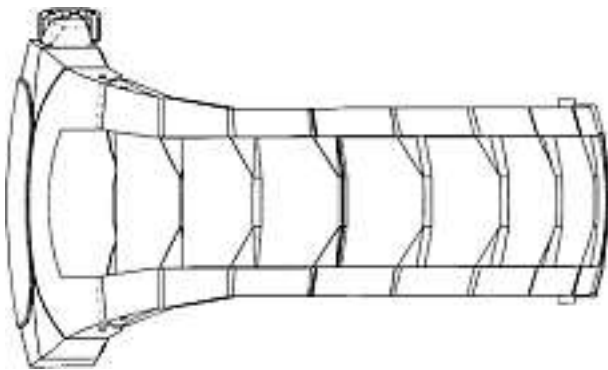

M13458-27

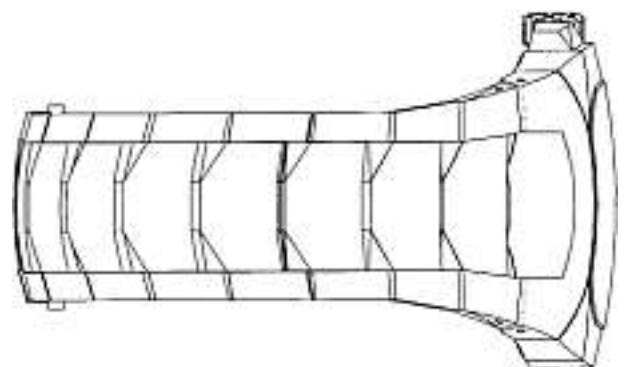
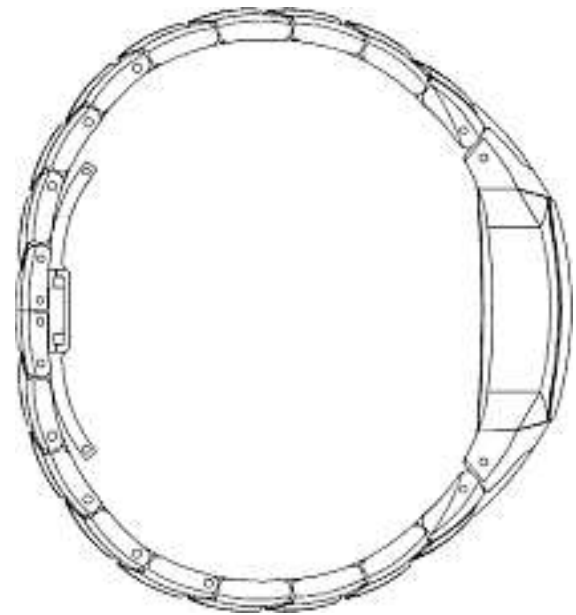

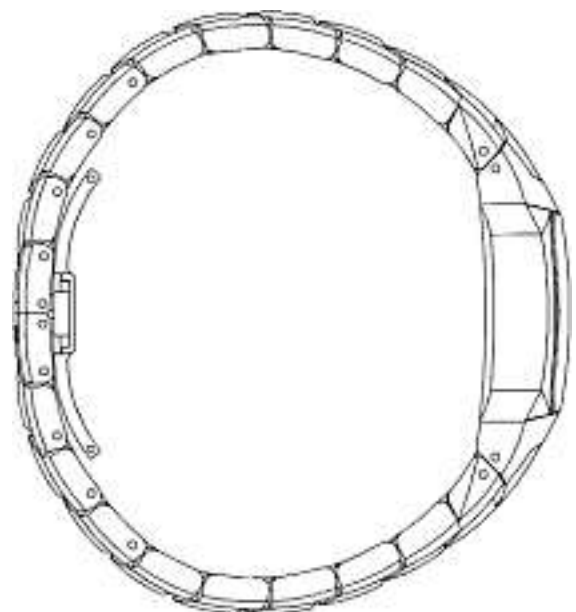
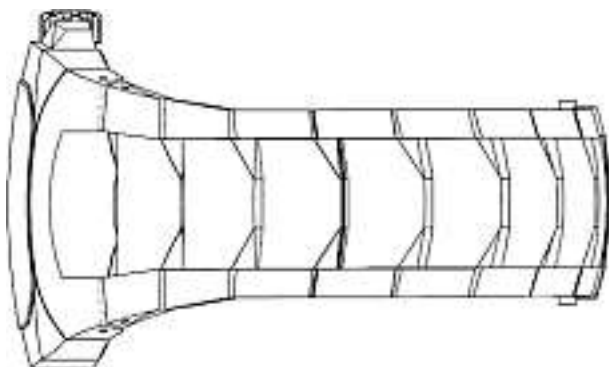
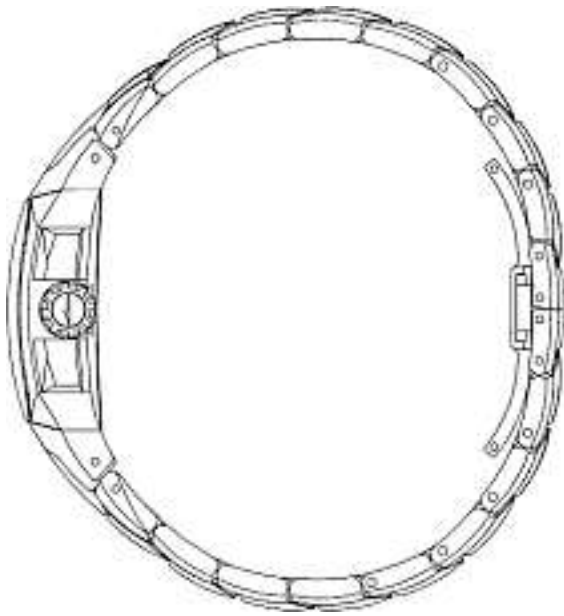

M13458-28

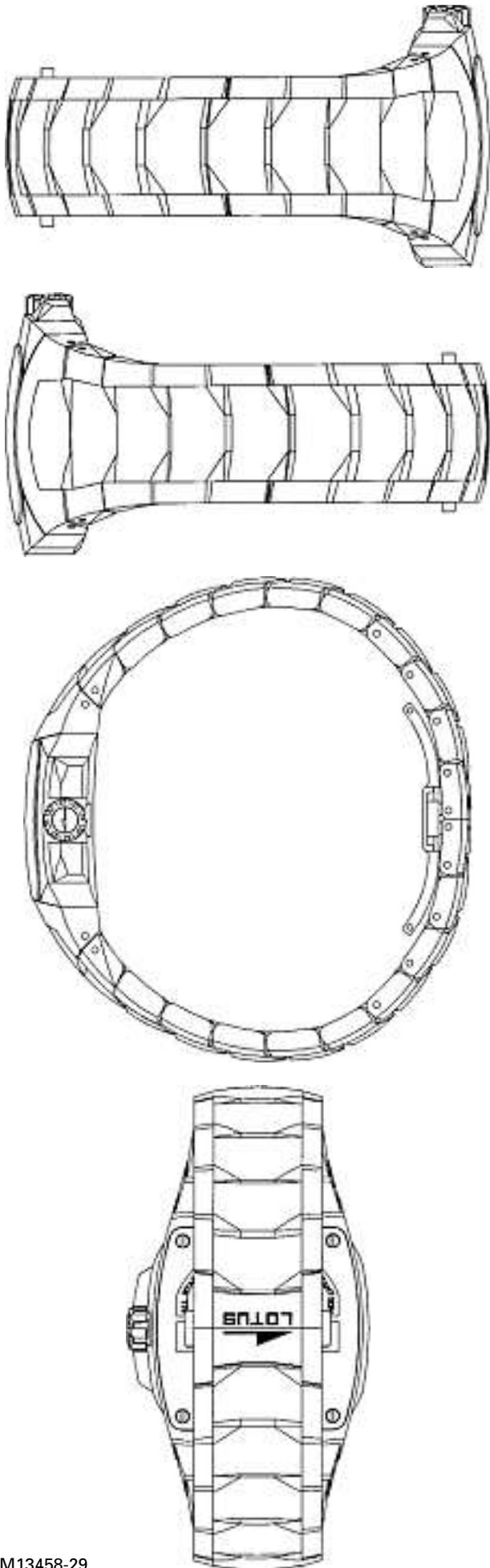

Cl. 11-01 134 728 21.12.2007  
3 design – bagues  
Déposant: Vernon White, 237 Florida Road, Morningside,  
Durban 4001, ZA  
Mandataire: Bugnion S.A., 1211 Genève 12 - Champel  
Priorité: ZA, 02.07.2007



1

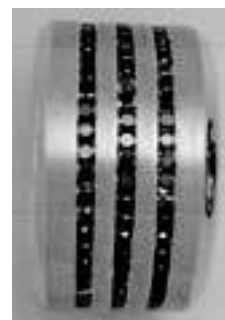



2



3

Cl. 12-11                      **134 729**                      21.01.2008  
 1 Design – Fahrrad-Zubehör  
 Hinterleger: Matsushita Electric Industrial Co., Ltd., 1006,  
 Oaza Kadoma, Kadoma-shi, Osaka 571-8501, JP  
 Designer: Shuhei Miyamoto, Osaka  
 Vertreter: Bovard AG, 3000 Bern 25  
 Priorität: JP, 11.12.2007

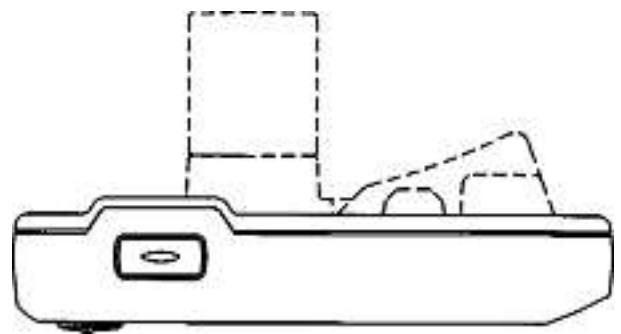
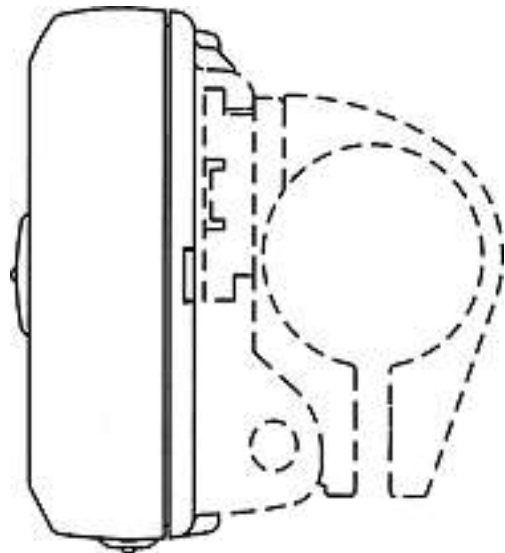
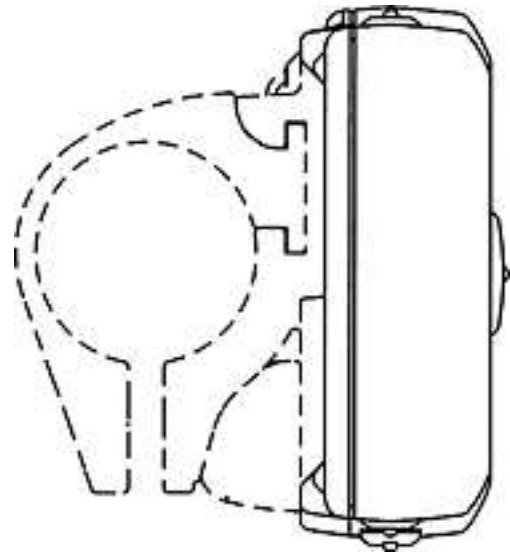
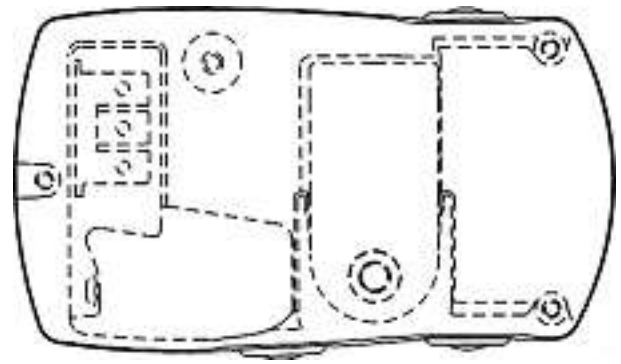
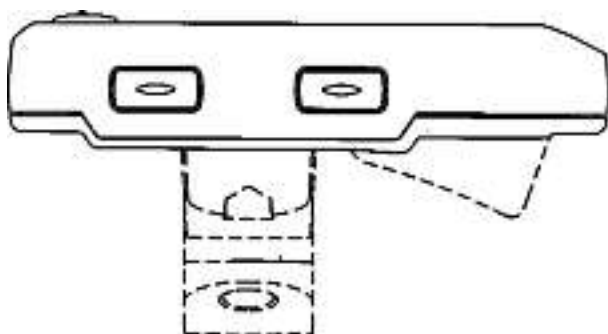
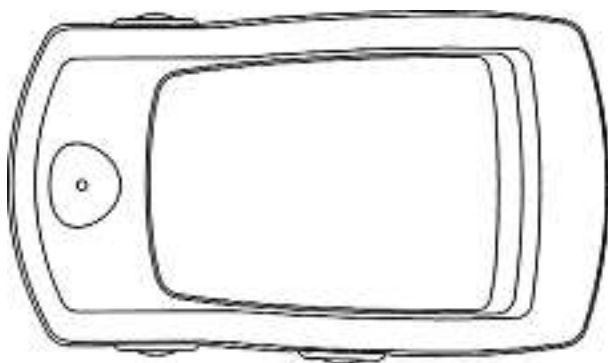

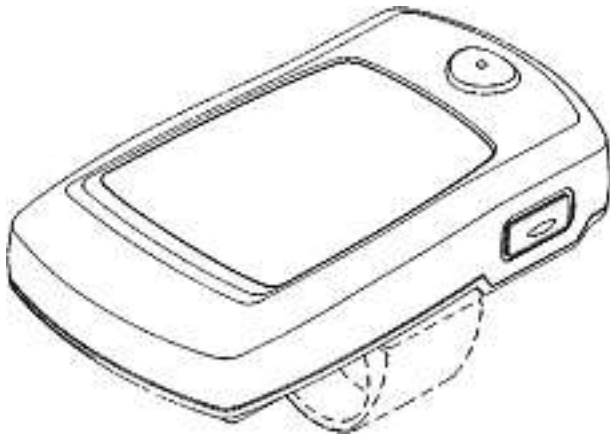

300640

Cl. 13-03      **134 730**      25.01.2008  
 8 design – capteurs électriques  
 Déposant: Liaisons Electroniques-Mécaniques LEM SA,  
 Chemin des Aulx 8, 1228 Plan-les-Ouates  
 Designer: Benjamin Marcoz, Collonges-sous-Saleves  
 Mandataire: reuteler & cie S.A., 1260 Nyon

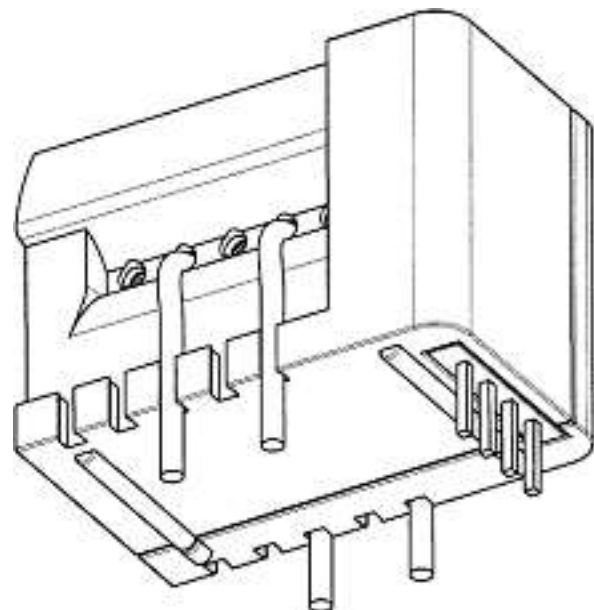
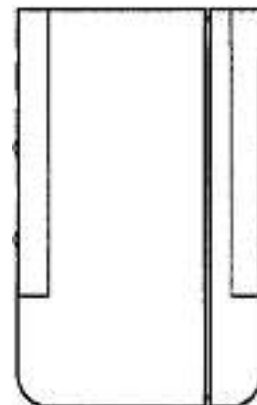
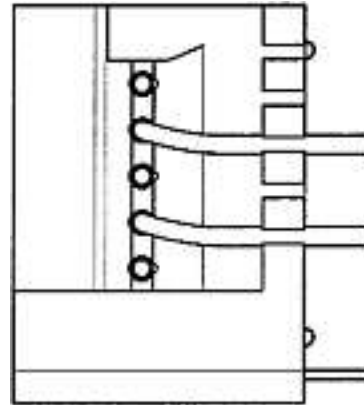
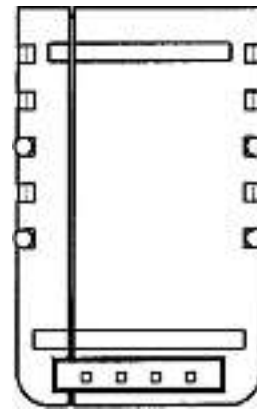
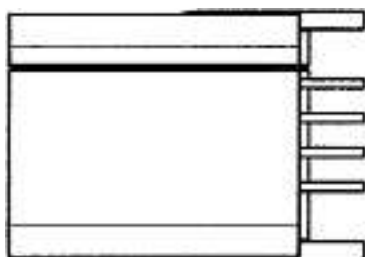
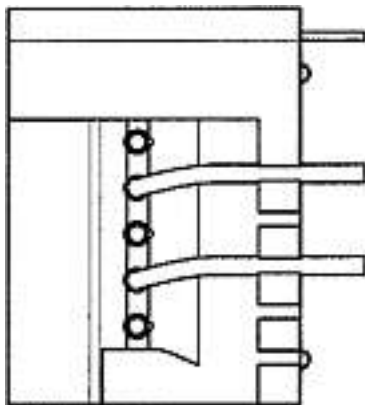

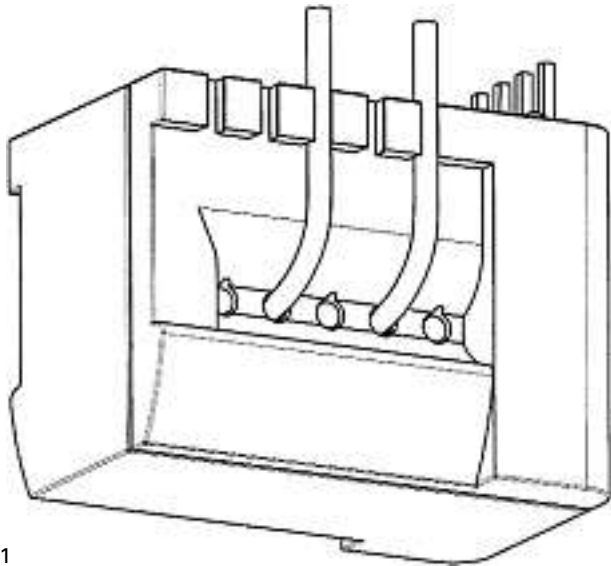
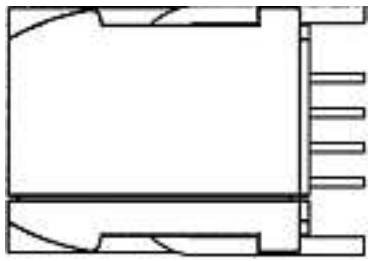

1

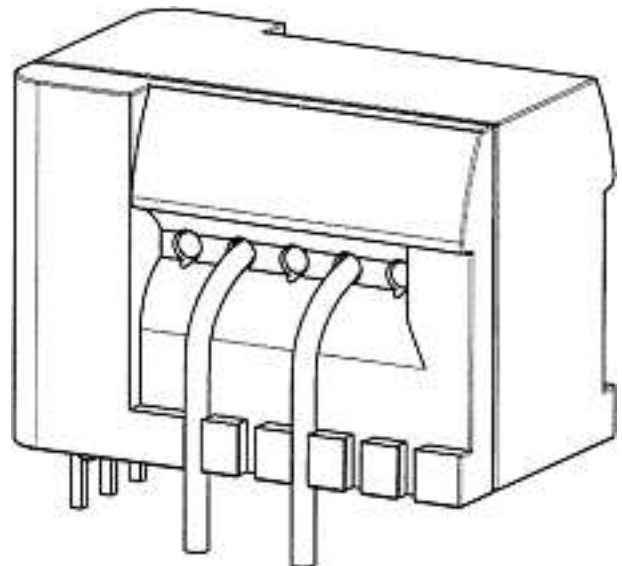
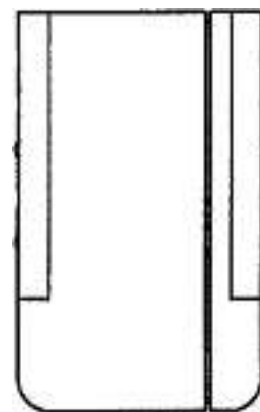
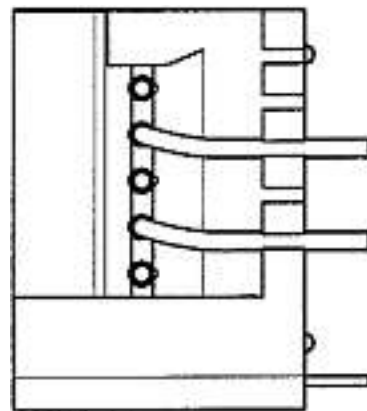
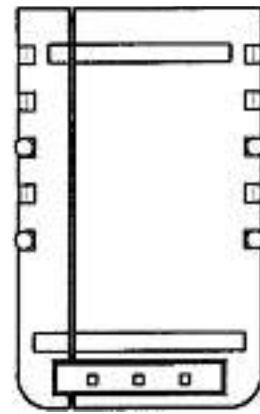
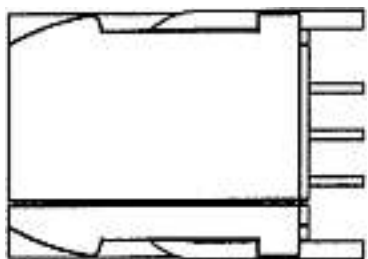
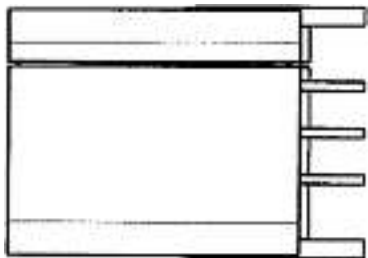
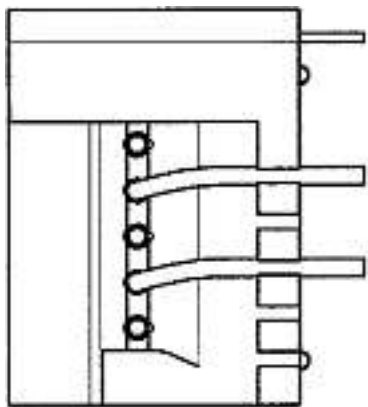

2

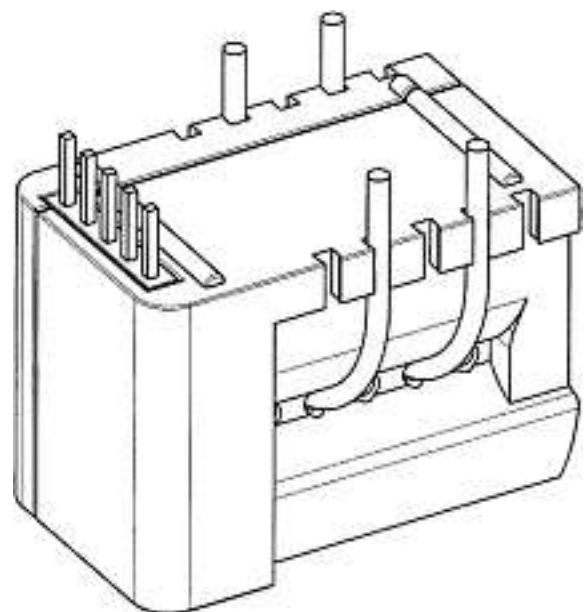
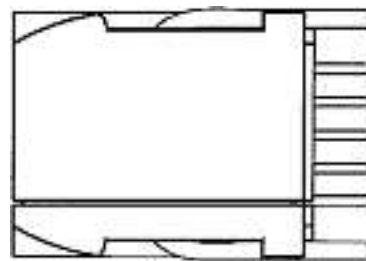
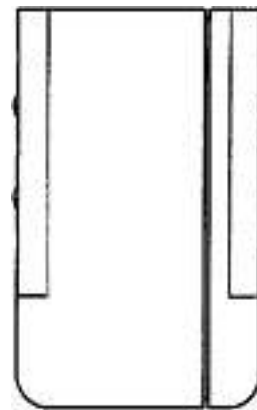
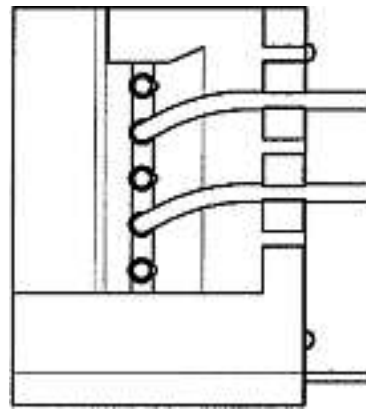
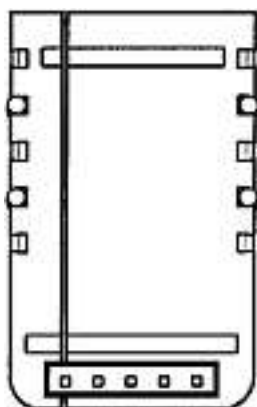
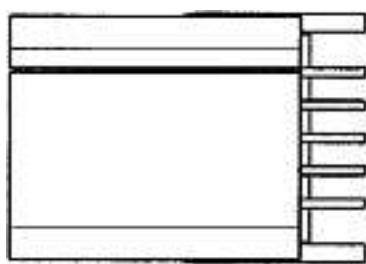
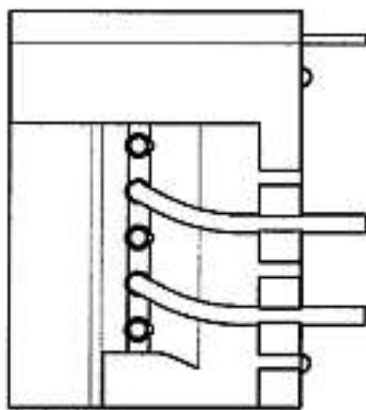
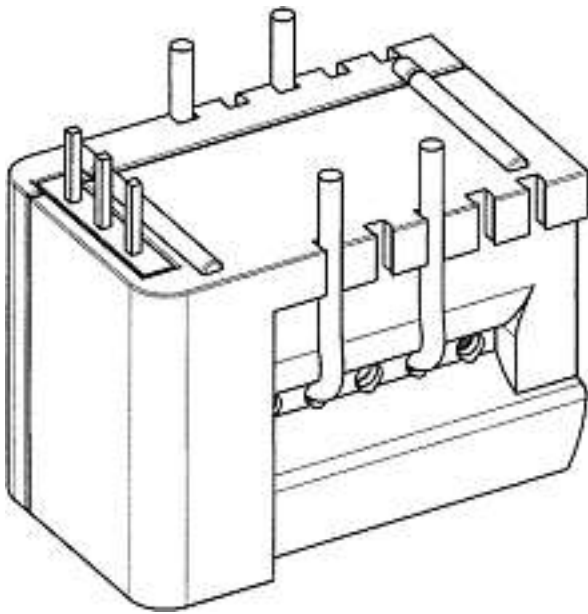

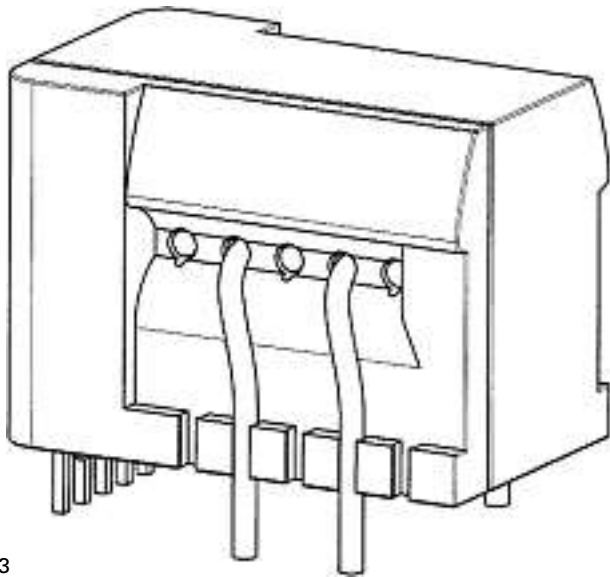

3

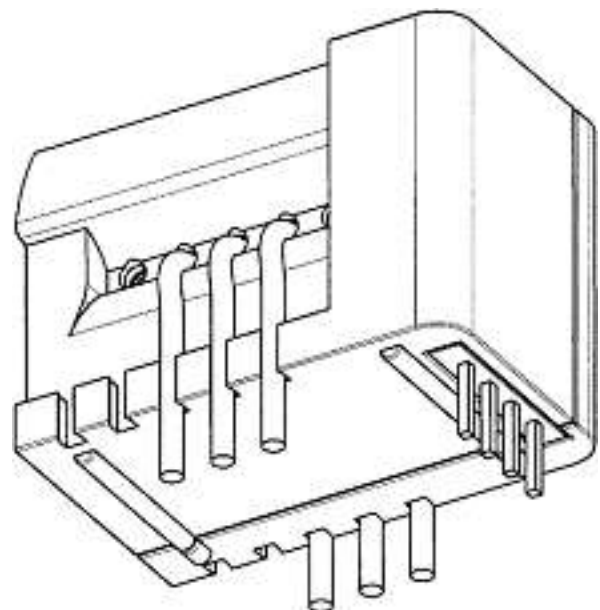
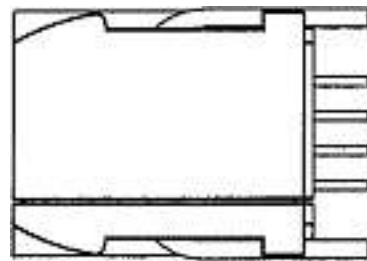
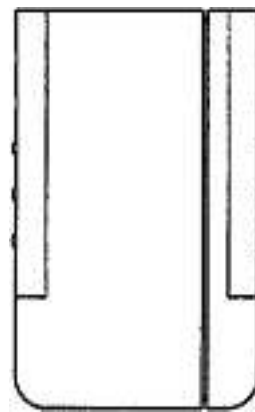
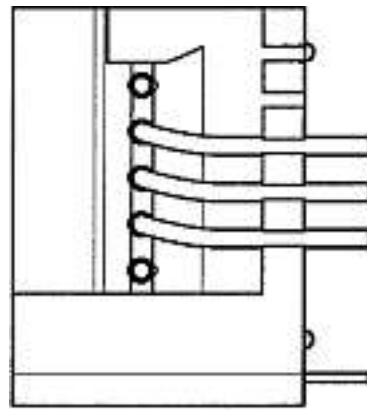
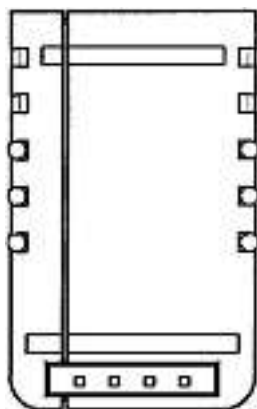
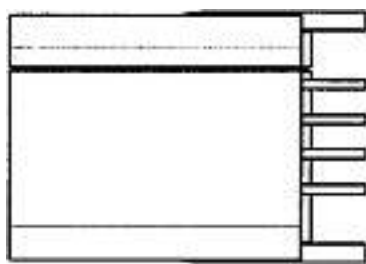
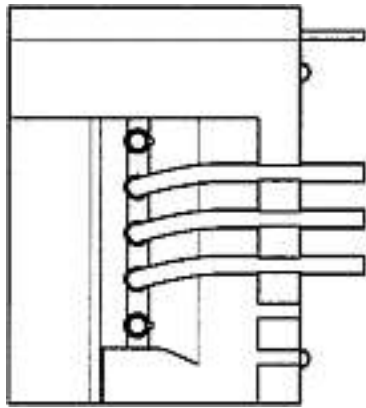

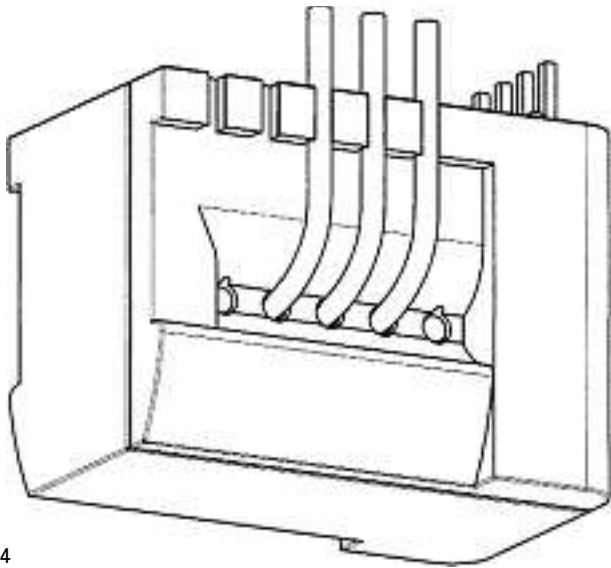

4

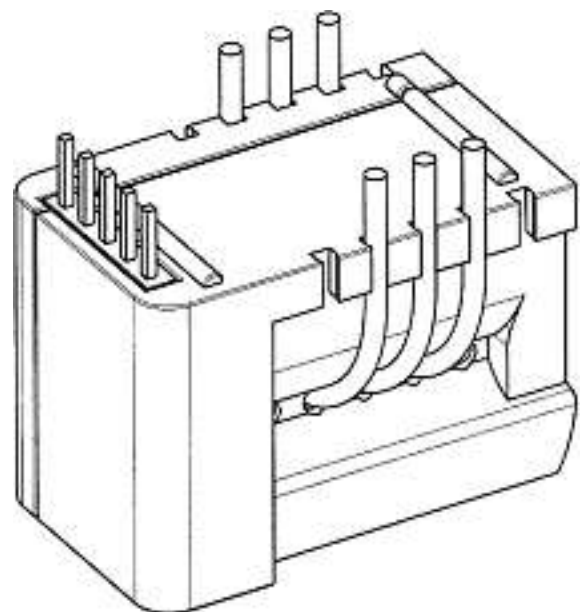
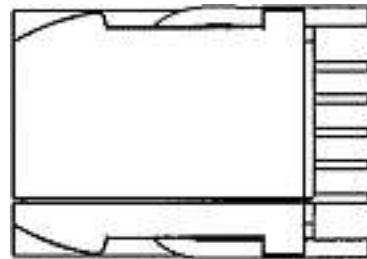
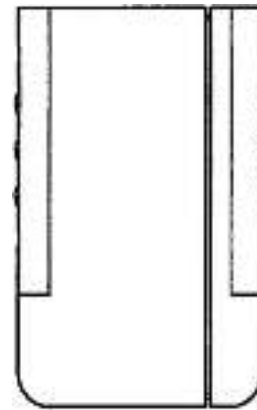
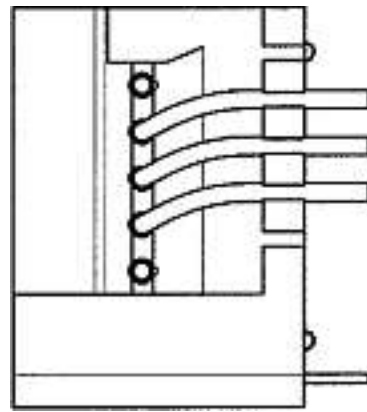
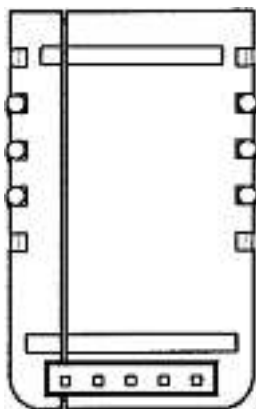
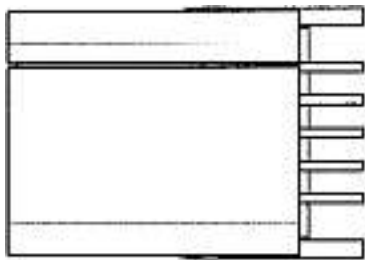
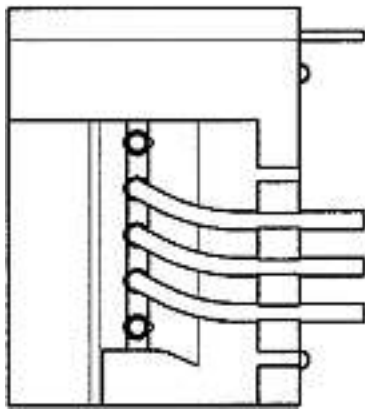

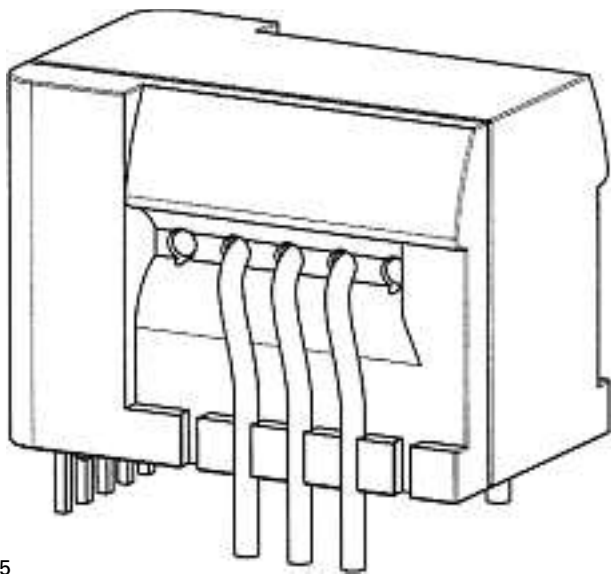

5

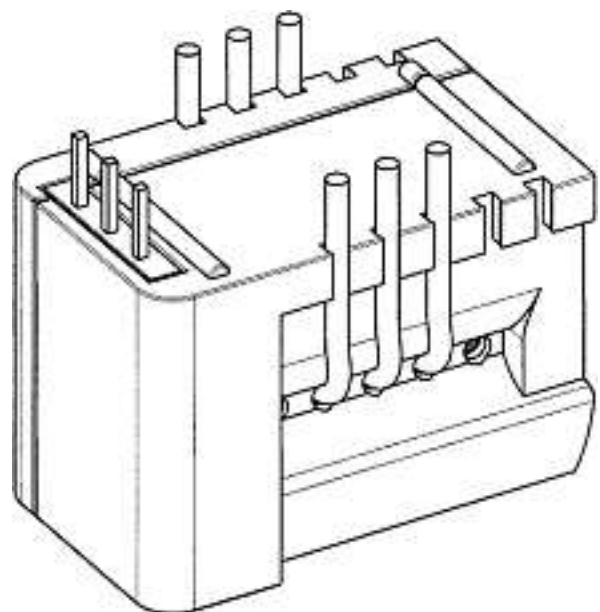
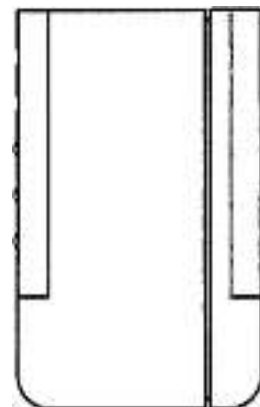
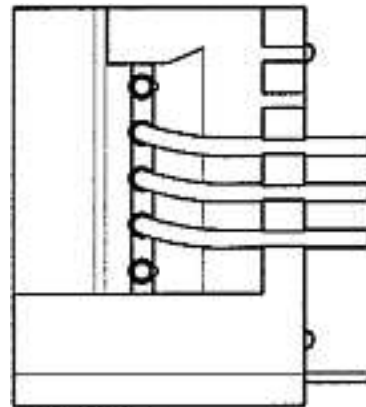
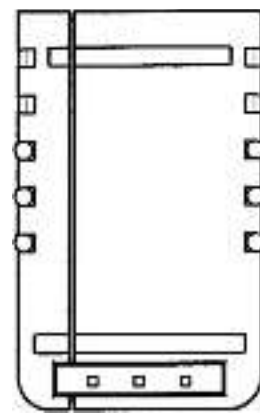
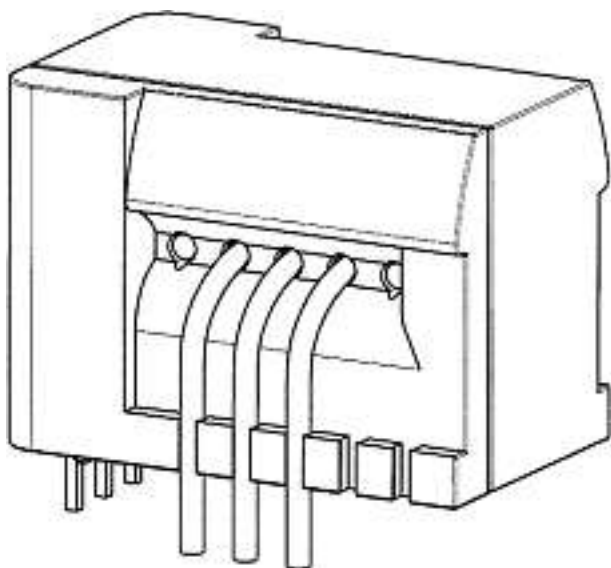
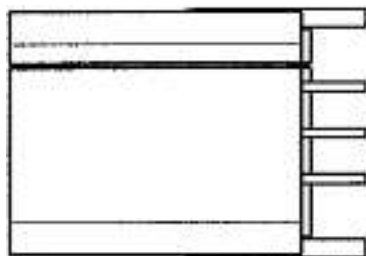
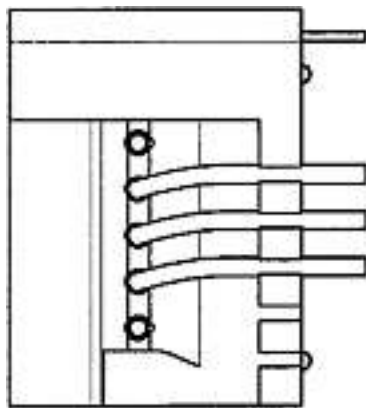

6

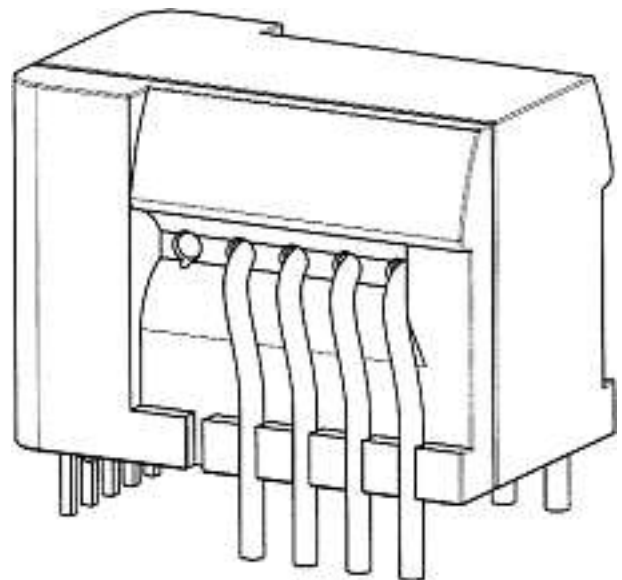
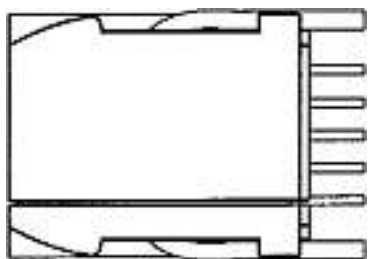
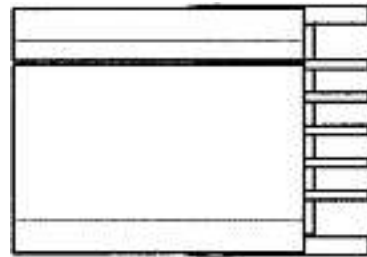
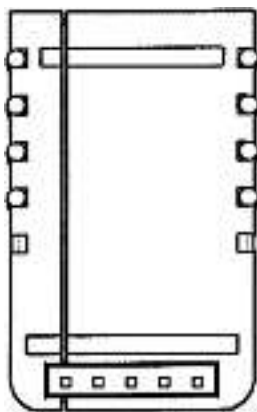
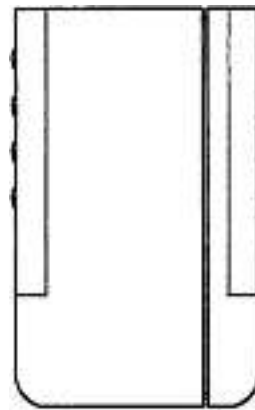
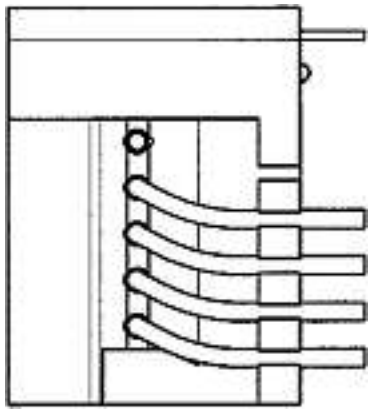
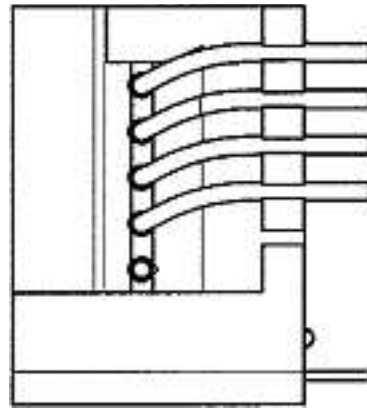
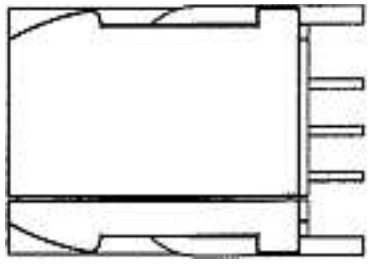



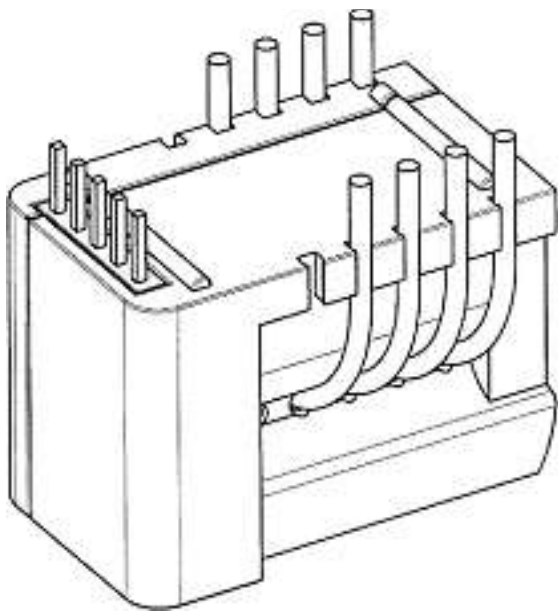

7

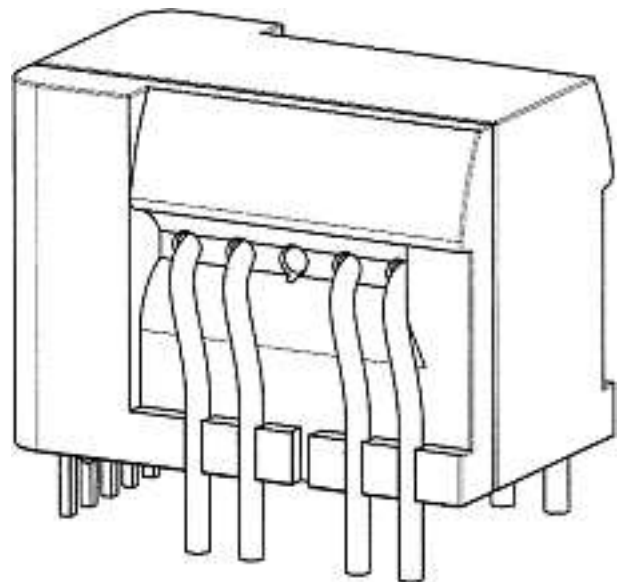
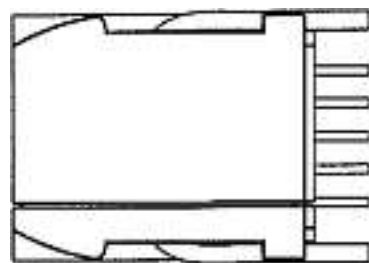
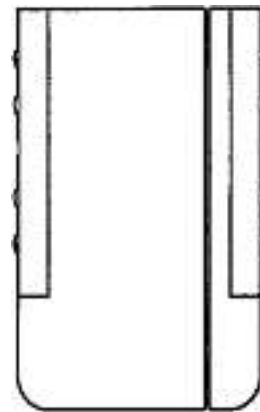
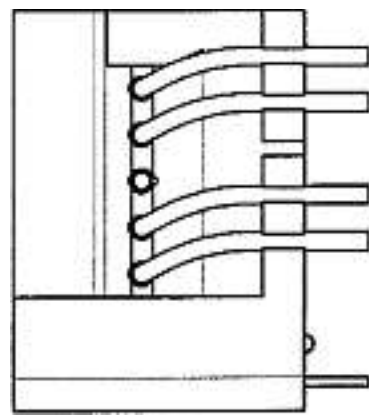
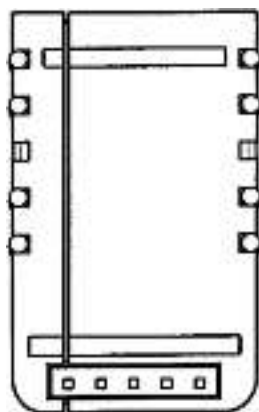
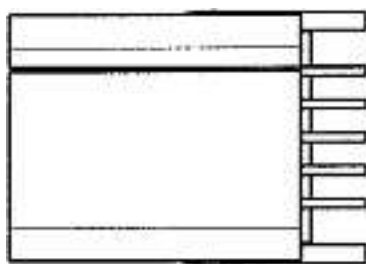
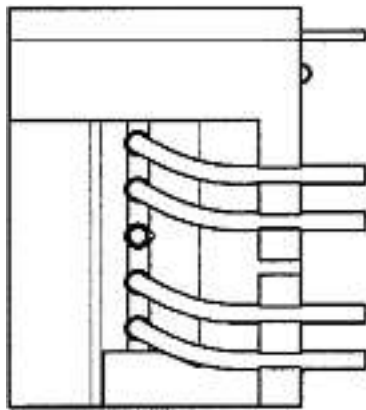

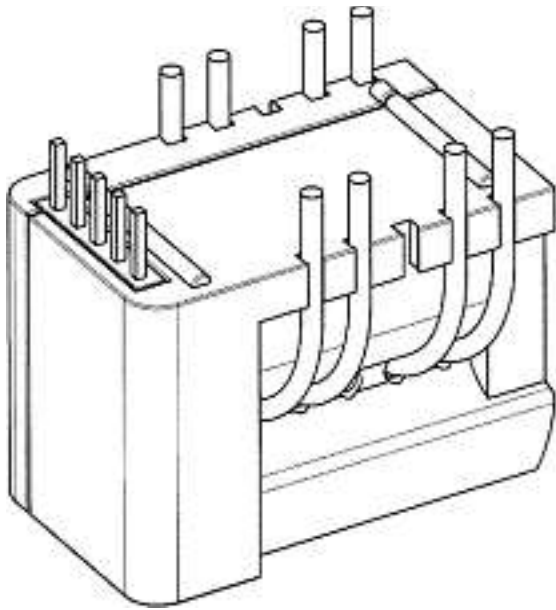

8

Cl. 14-02 **134 731** 29.01.2008  
 2 Design – Tonerkassette, Trommleinheit  
 Hinterleger: Brother Industries, Ltd, 15-1, Naeshiro-cho,  
 Mizuho-ku, Nagoya-shi / Aichi-ken, JP  
 Designer: Satoru Ishikawa, Nagoya; Hirofumi Sato, Nagoya;  
 Fumio Morita, Nagoya; Satoru Hattori, Nagoya; Tatsuo  
 Ogasawara, Nagoya; Yasuo Fukamachi, Nagoya  
 Vertreter: E. Blum & Co. AG, Patent- und Markenanwälte VSP,  
 8044 Zürich  
 Priorität: JP, 10.08.2007; JP, 10.08.2007

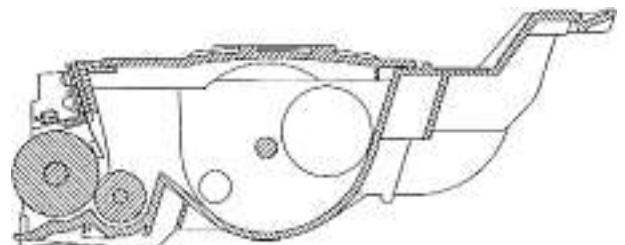
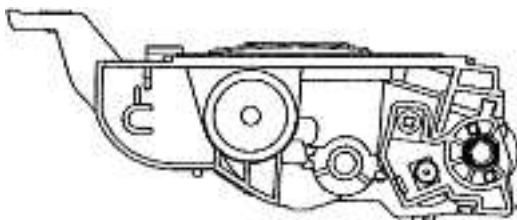
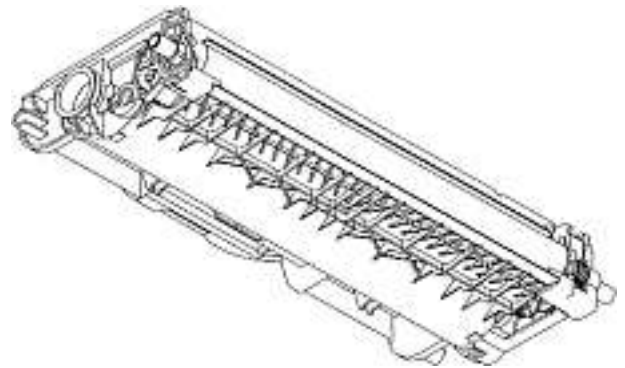
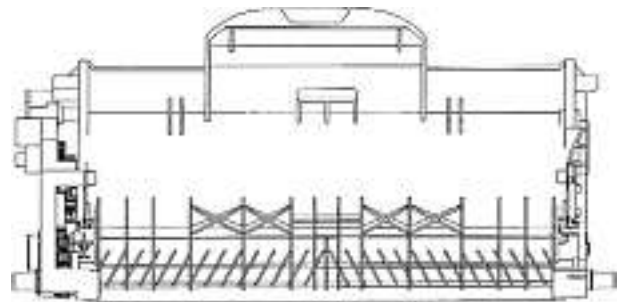
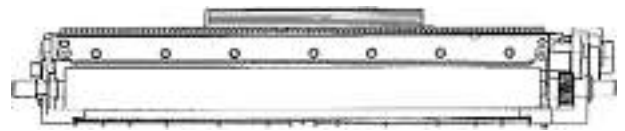

A-2007/1058a

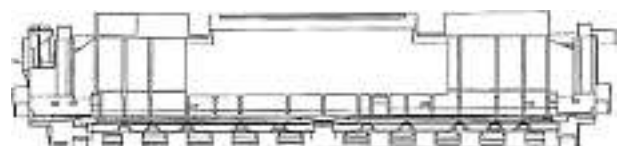
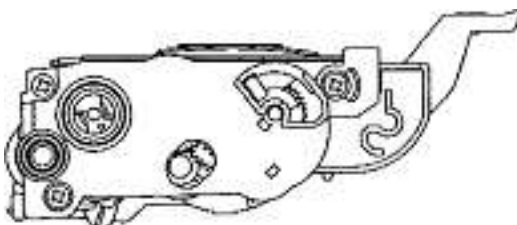

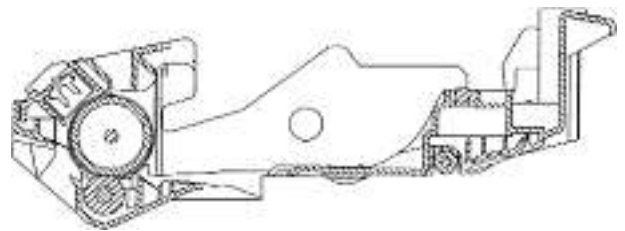
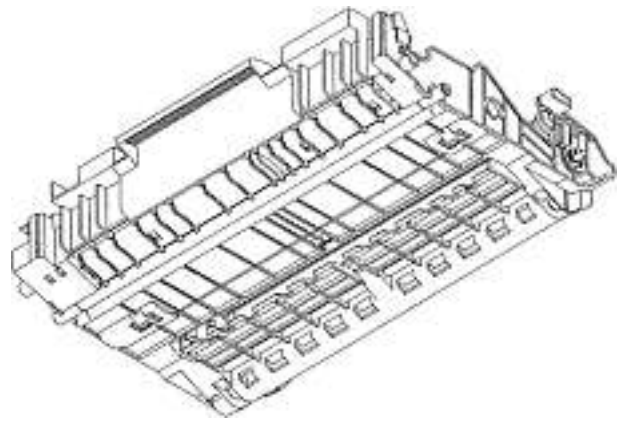
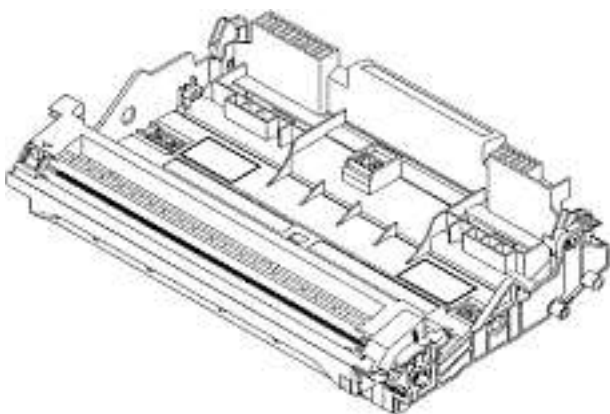
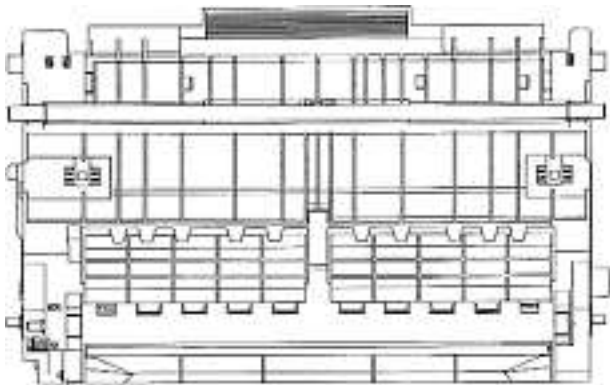
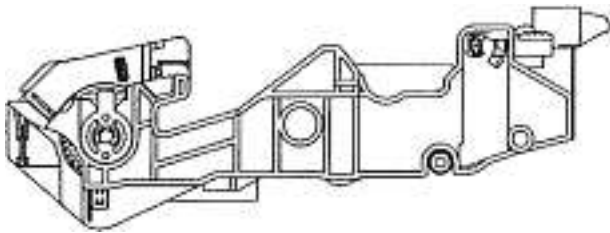
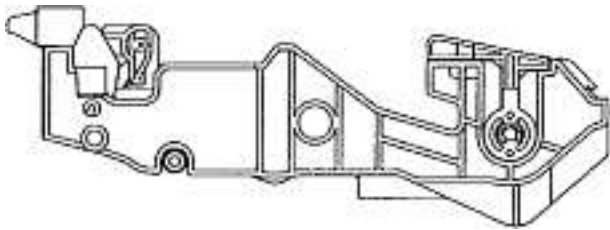
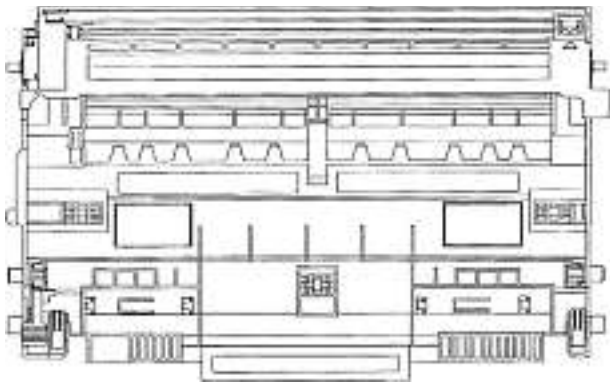

A-2007/1058b

Cl. 15-05 **134 732** 23.01.2008  
 2 Design – Staubsauger  
 Hinterleger: Aktiefbolaget Electrolux, St. Göransgatan 143,  
 105 45 Stockholm, SE  
 Designer: Christian Agren, Stockholm  
 Vertreter: Troesch Scheidegger Werner AG, Patent- und  
 Markenanwälte, 8126 Zumikon  
 Priorität: EM, 27.11.2007

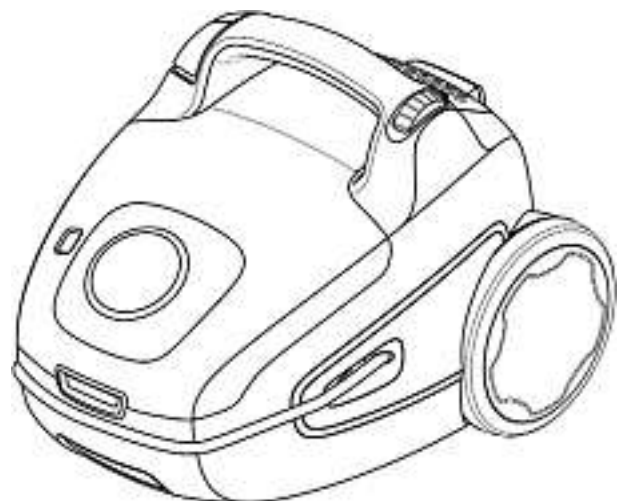

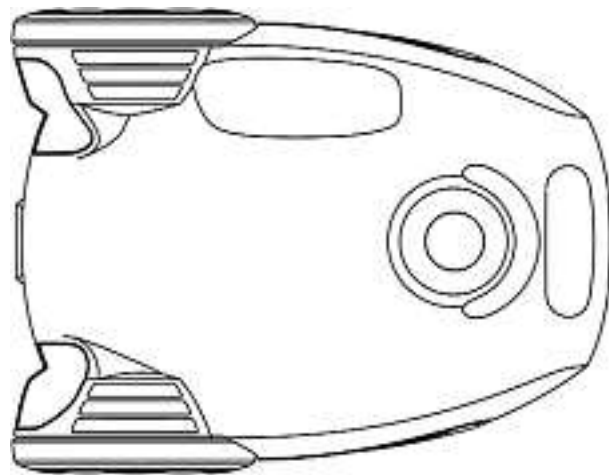
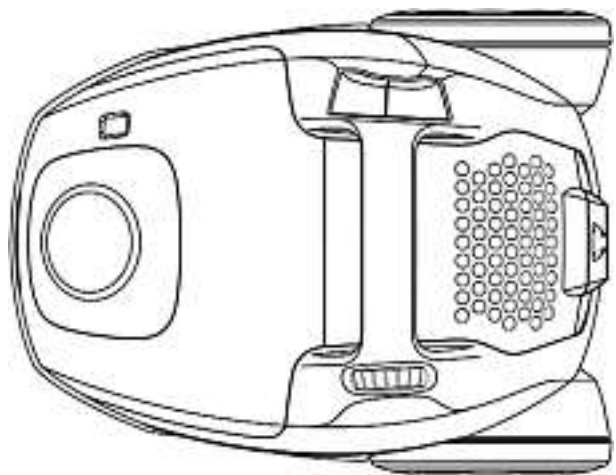
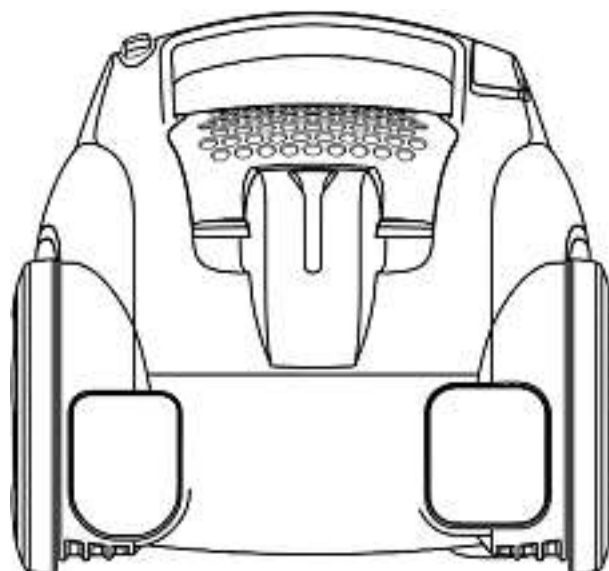
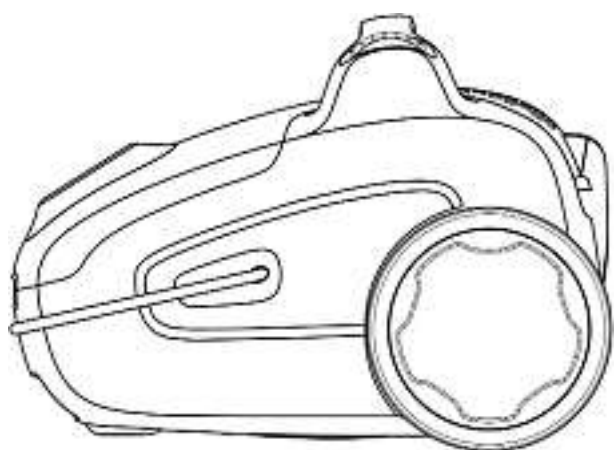
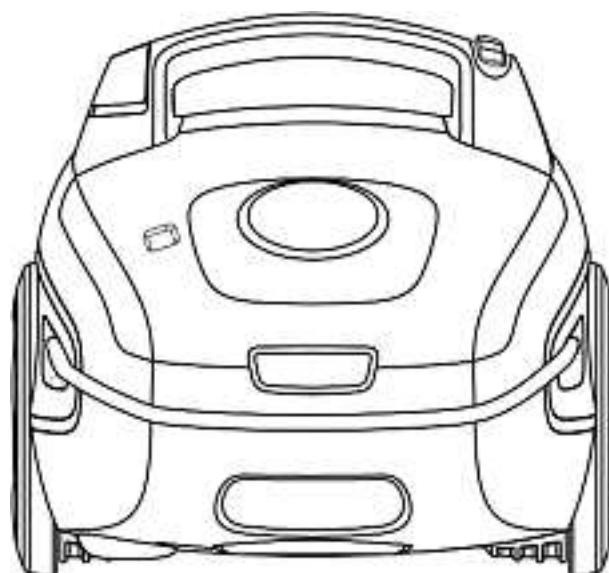
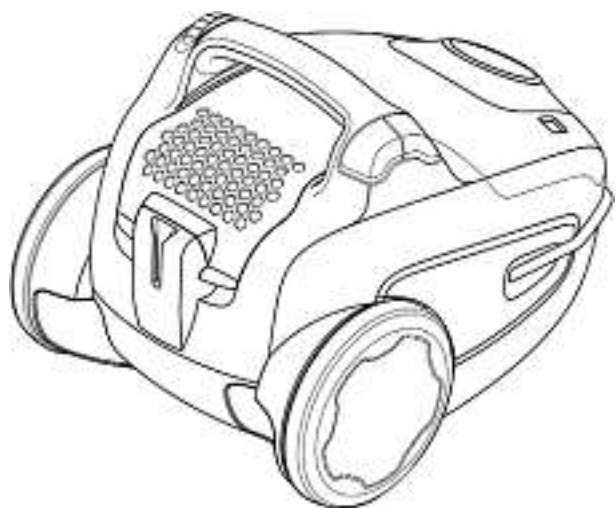

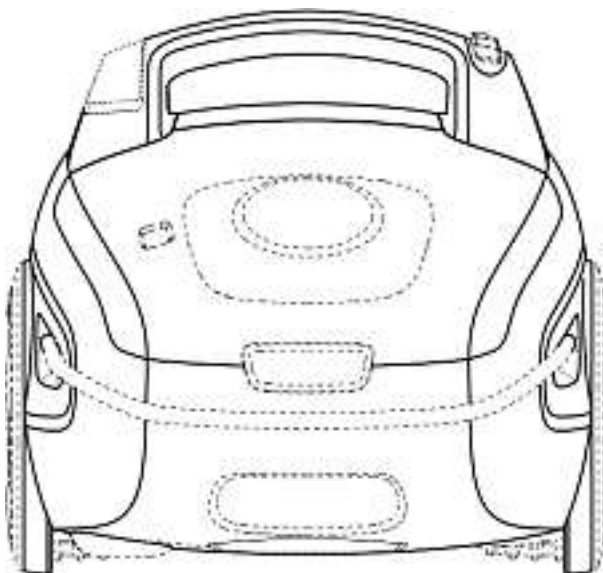
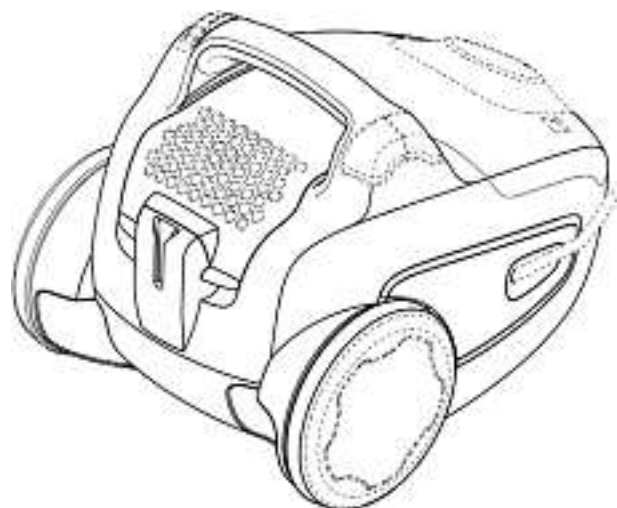
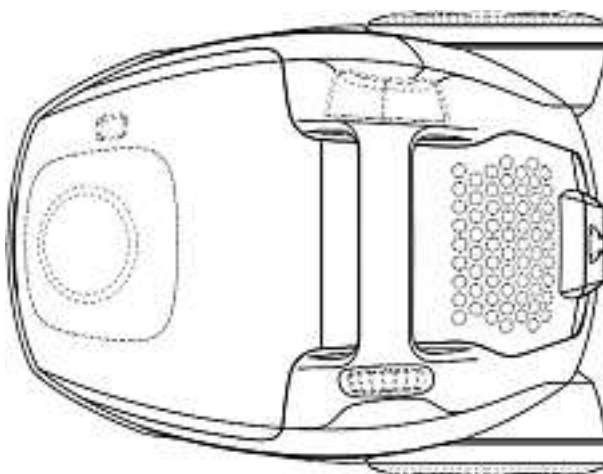
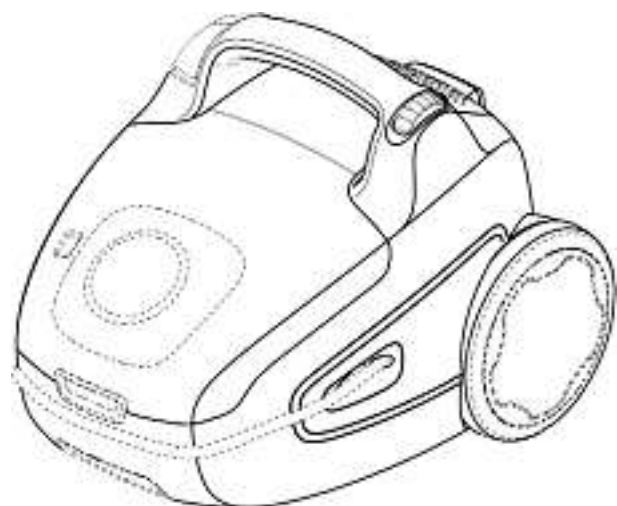
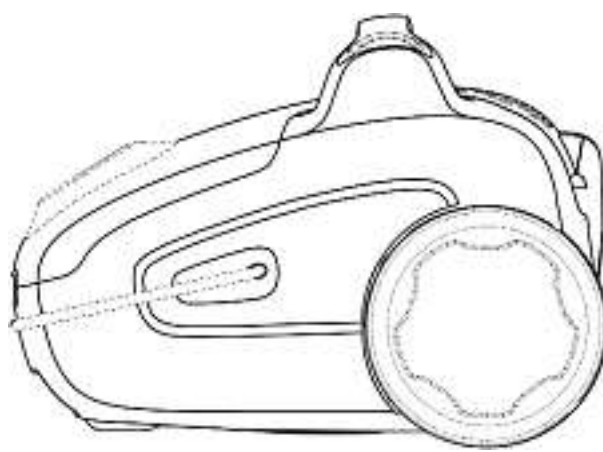
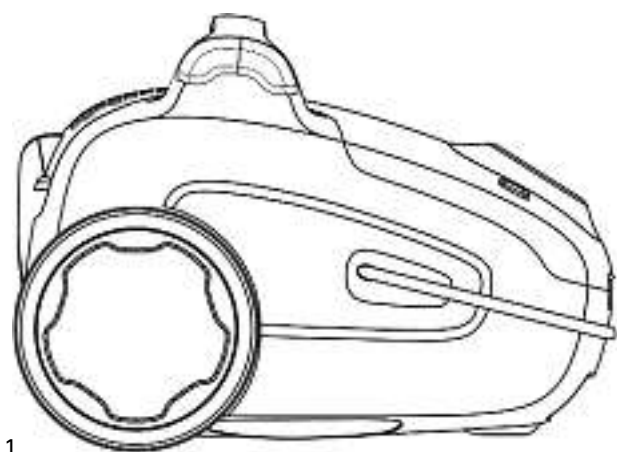

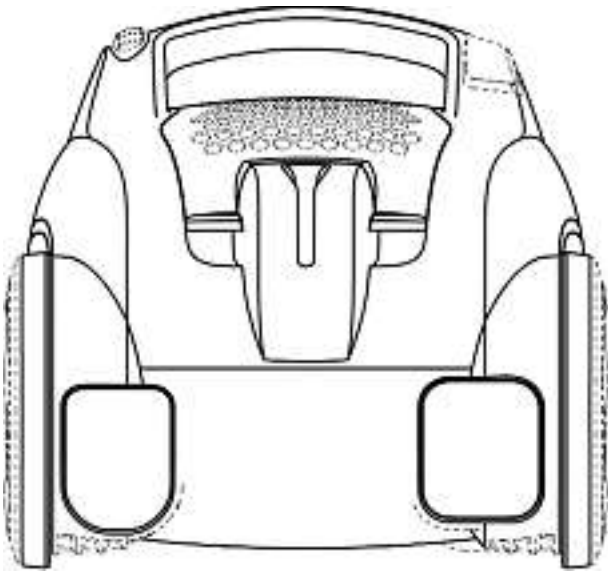

Kuh

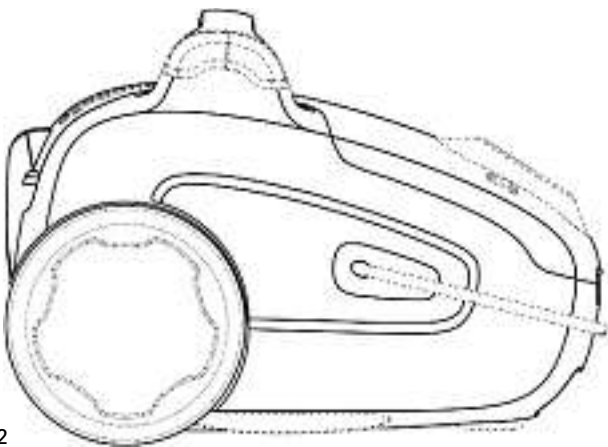
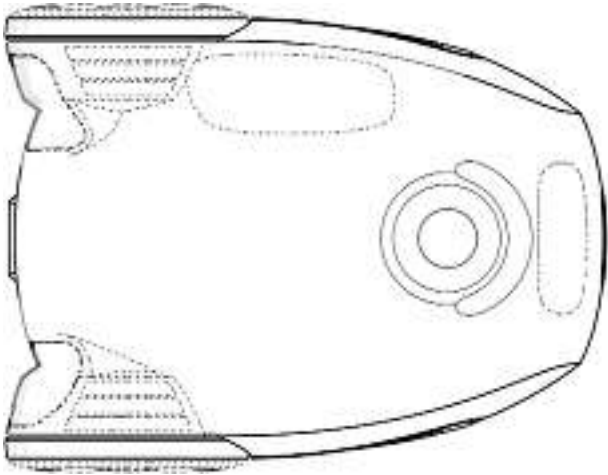

2

Cl. 21-01 **134 734** 12.01.2008  
2 Design – Spiel-Bauklotz  
Hinterleger: Werner Zemp, Rehweg 2, 8044 Gockhausen

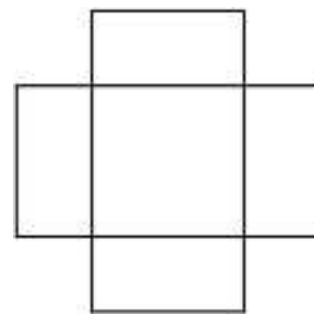
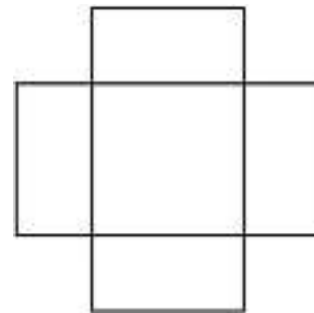
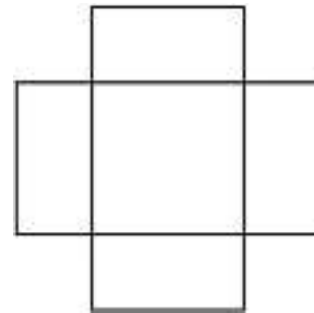

Cl. 19-08 **134 733** 21.01.2008  
1 Design – Druckvorlage  
Hinterleger: alba Albin Breitenmoser AG, Zielstrasse 38,  
9050 Appenzell  
Designer: Michael Steinlin, Teufen

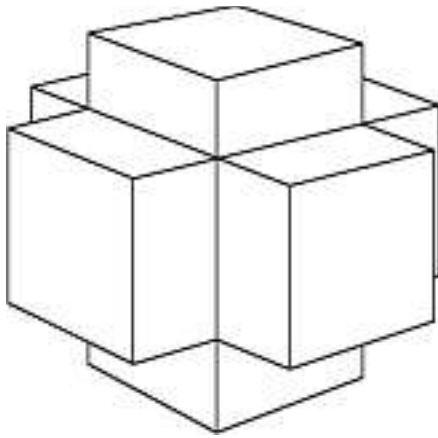

1

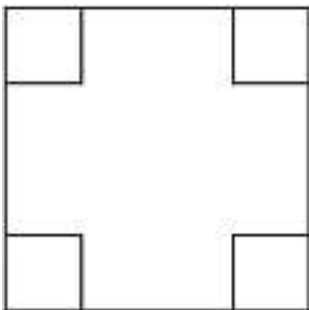
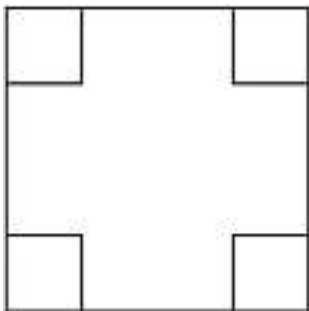
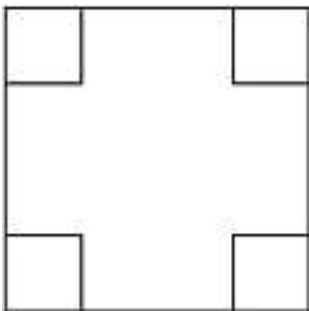

2

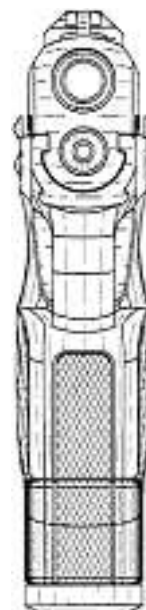

Cl. 22-01                      134 735                      22.01.2008  
 6 design – pistolets  
 Déposant: Sturm, Ruger & Company, Inc., One Lacey Place,  
 Southport, CT 06890, US  
 Designer: James McGarry, Prescott Valley  
 Mandataire: Kirker & Cie S.A., Ingénieurs-Conseils,  
 1226 Genève - Thônex  
 Priorité: US, 25.07.2007

1

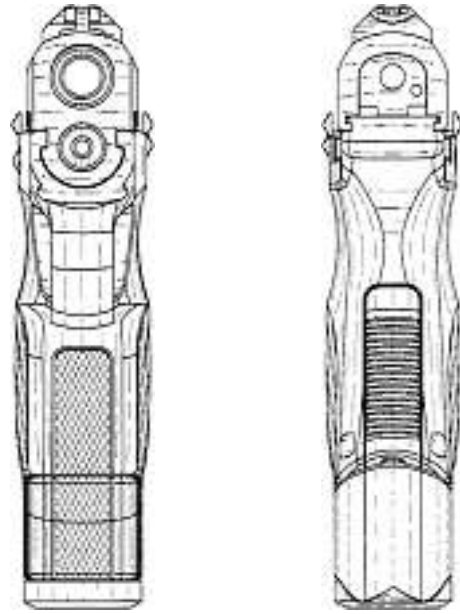
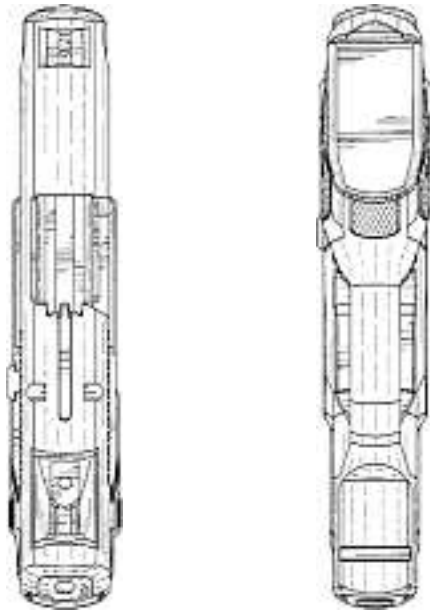

2

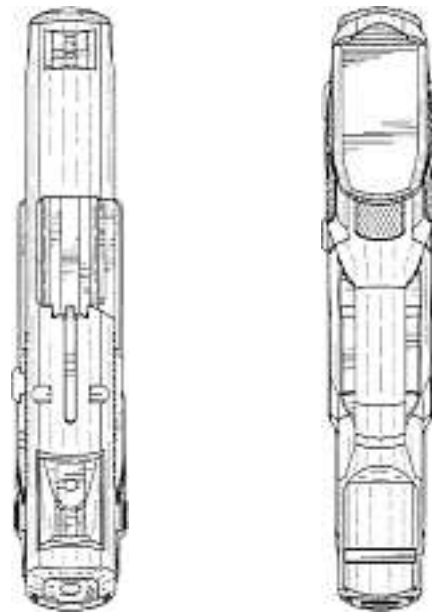



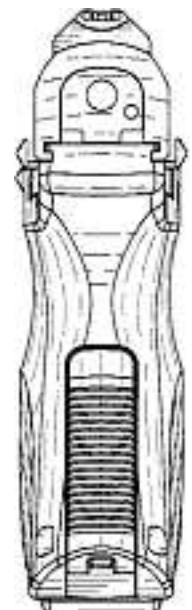
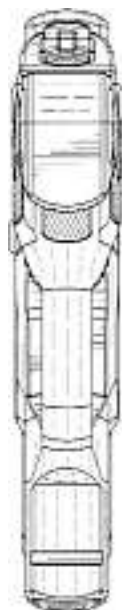
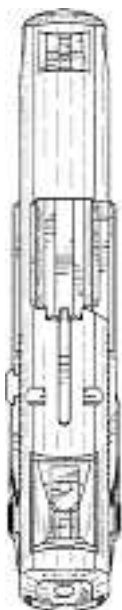
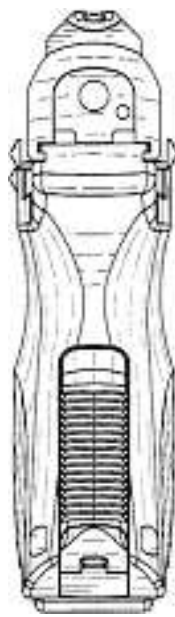
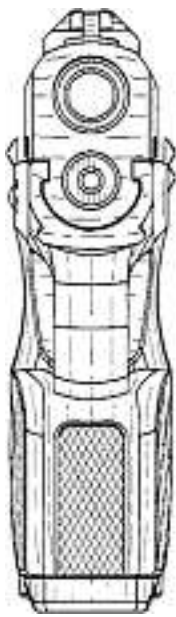

4

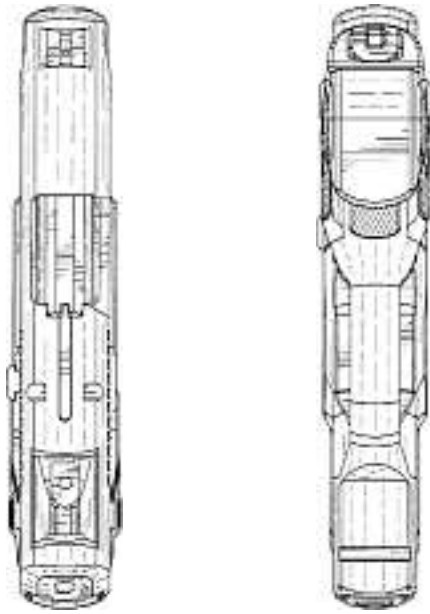

5

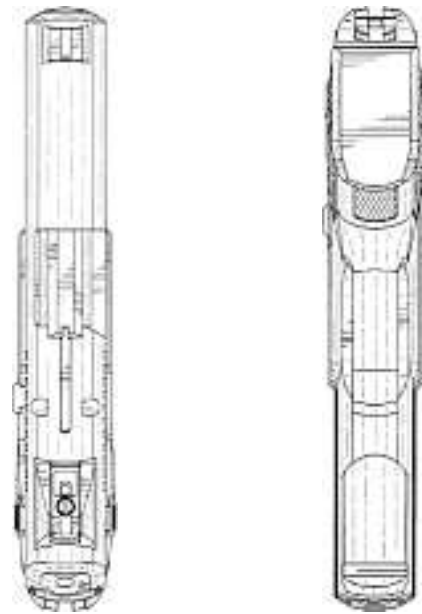
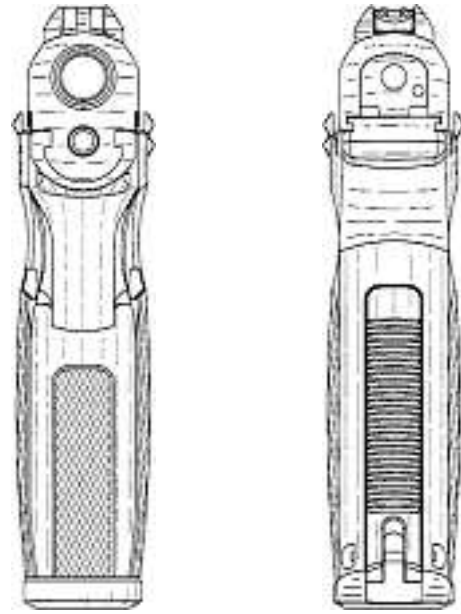



Cl. 23-01, 23-02 **134 736** 21.12.2007  
10 Design – Armaturen, Abläufe, Überläufe  
Hinterleger: Niro-Plan AG, Franke-Strasse 2, 4663 Aarburg  
Designer: Lutz Gebhardt, Zug; Gerd Rüttbauer, Schwörstadt;  
Andre Rudolf, Unterkulm  
Vertreter: R. A. Egli & Co., Patentanwälte, 8008 Zürich  
Priorität: EM, 10.07.2007

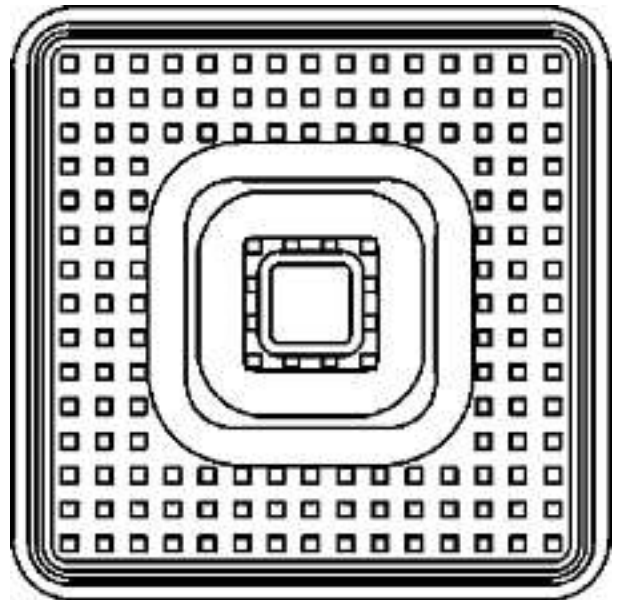
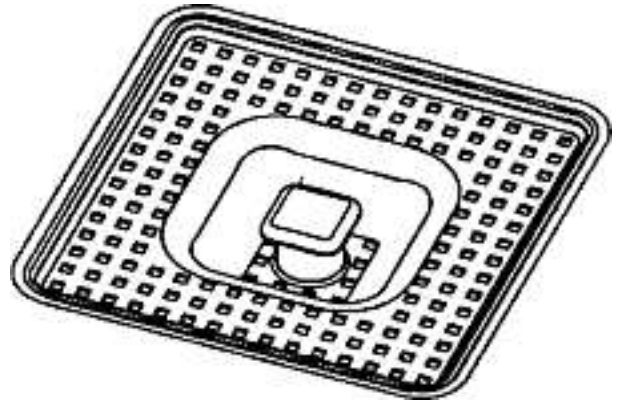
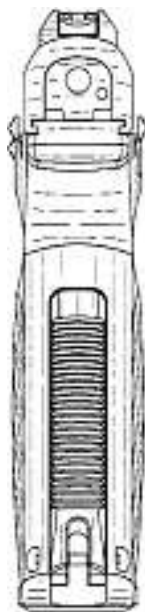
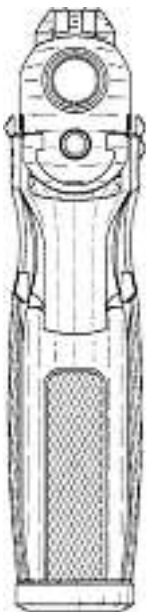

1

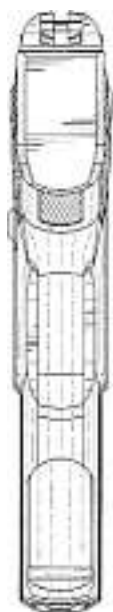

2

6



3

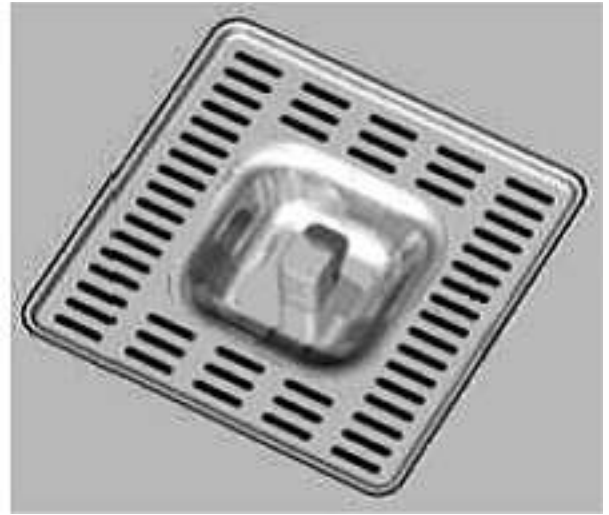

6

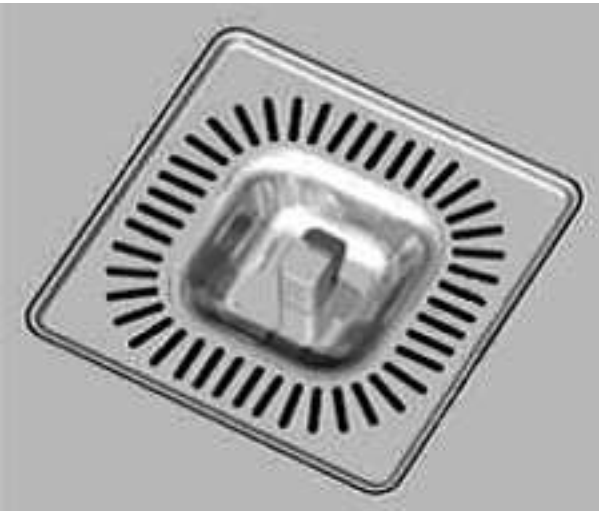

4

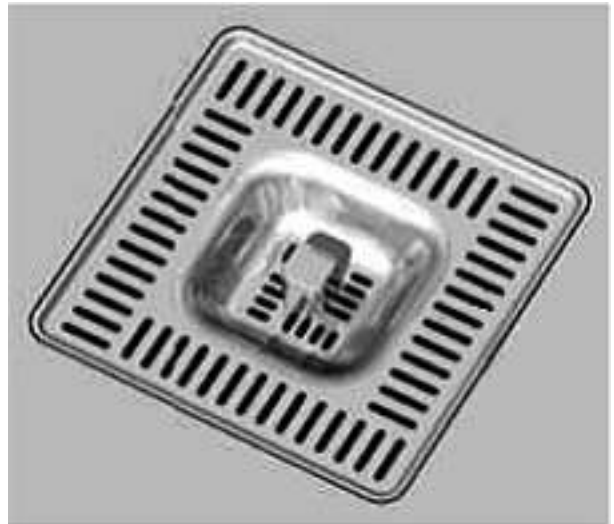

7

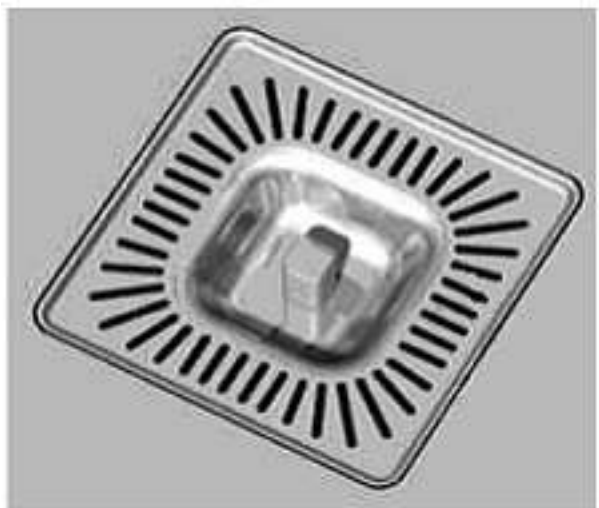

5

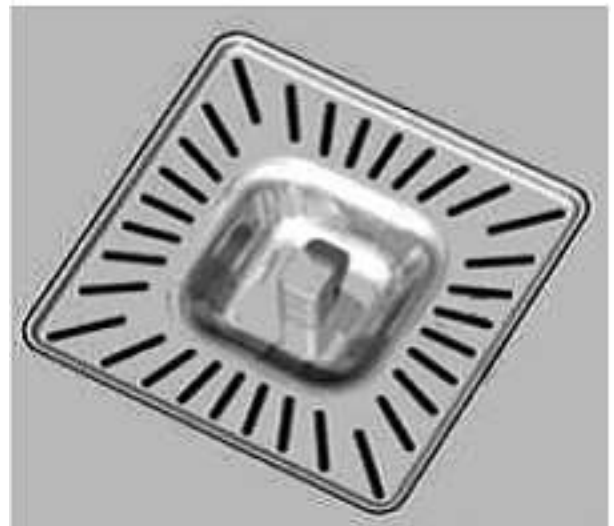

8

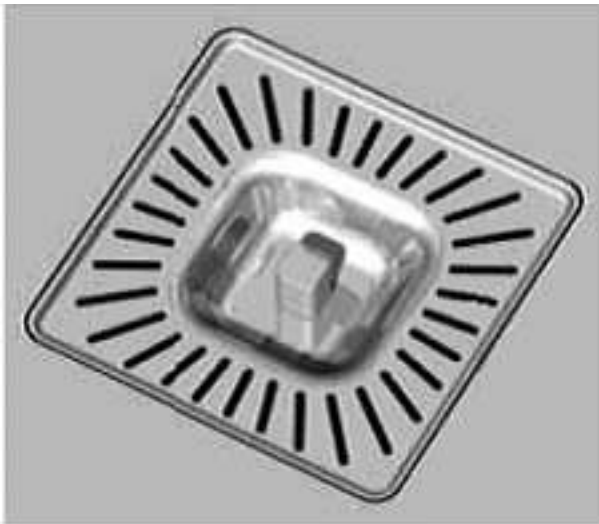

9



10

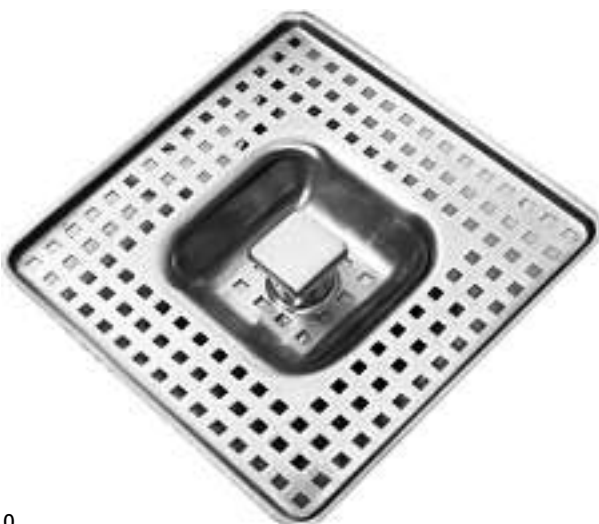

Cl. 23-02 134 737 17.01.2008  
 3 Design – Waschbecken  
 Hinterleger: Bagno Sasso AG, Schulstrasse 76,  
 7302 Landquart  
 Designer: Tilo Gnausch, Zürich

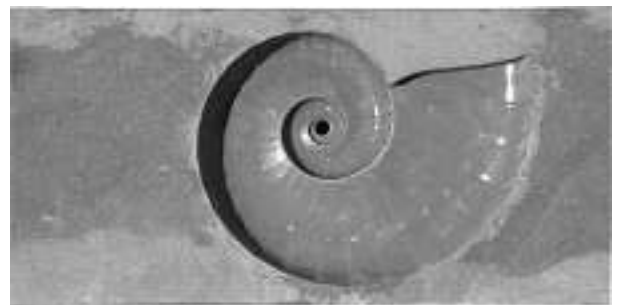

1

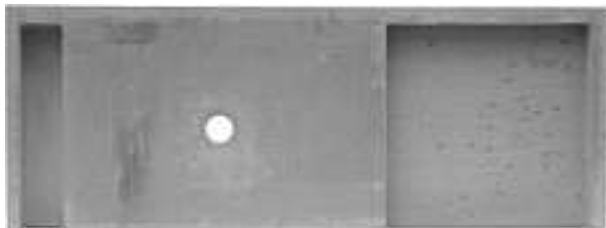
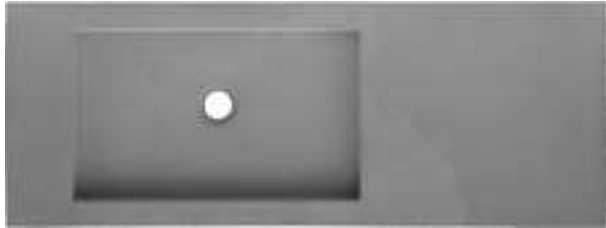

2

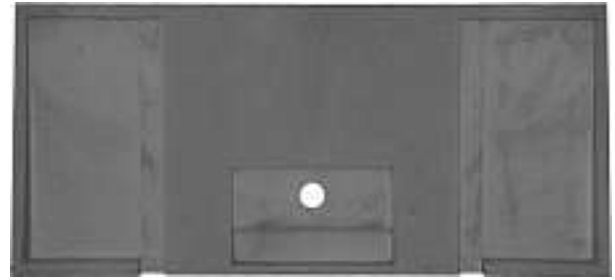

3

Cl. 26-05

134 740

18.12.2007

4 Design – Lampen

Hinterleger: Lumess AG, Lettenweg 118, 4123 Allschwil

Designer: Elia Gilli, Basel



42030.01



11060.01

11670.02



11671.02



Cl. 26-05                      **134 741**                      03.01.2008  
 3 Design – Lampen  
 Hinterleger: Uta Burchard-Bär, Schaffhauserstrasse 105,  
 8057 Zürich



Tin-light



Tin-light plus



Tin-light up side down

Cl. 26-05                      **134 742**                      03.01.2008  
 1 Design – Stehleuchte  
 Hinterleger: Zumtobel Lighting GmbH, Schweizer Strasse 30,  
 Dornbirn, AT  
 Designer: Klaus Nolting, Hamburg  
 Vertreter: A. Braun, Braun, Héritier, Eschmann AG,  
 Patentanwälte, 4051 Basel  
 Priorität: EM, 06.07.2007

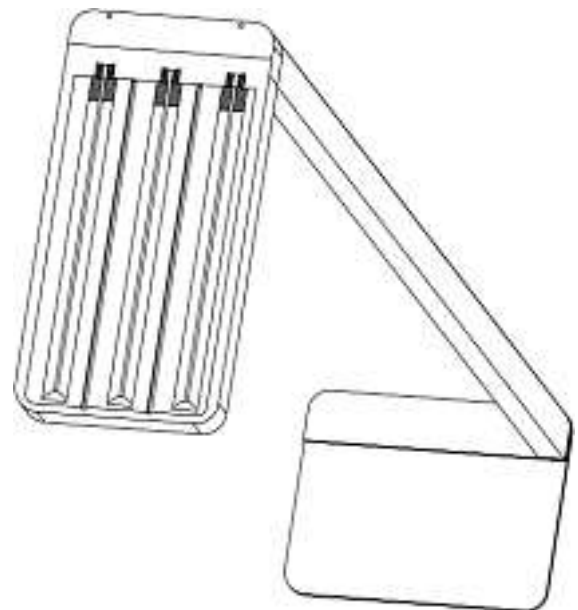

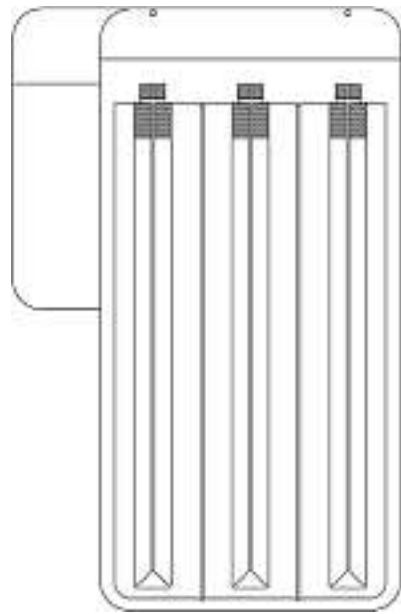
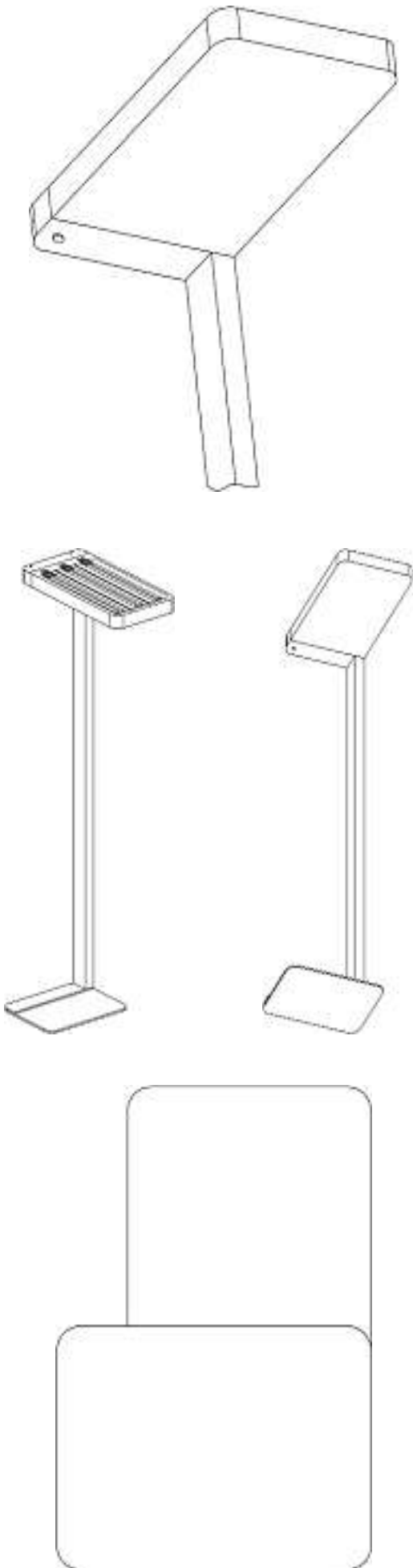

1

Cl. 26-05 **134 743** 11.01.2008  
1 Design – Leuchte  
Hinterleger: Herbert Waldmann GmbH & Co. KG, Peter-Henlein-Strasse 5, 78056 Villingen-Schwenningen, DE  
Designer: Gerhard Waldmann, Dauchingen  
Vertreter: R. A. Egli & Co., Patentanwälte, 8008 Zürich  
Priorität: DE, 10.08.2007

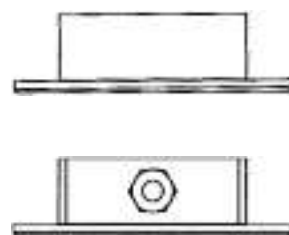





1

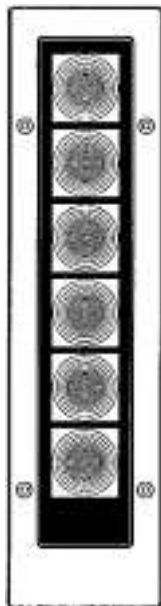
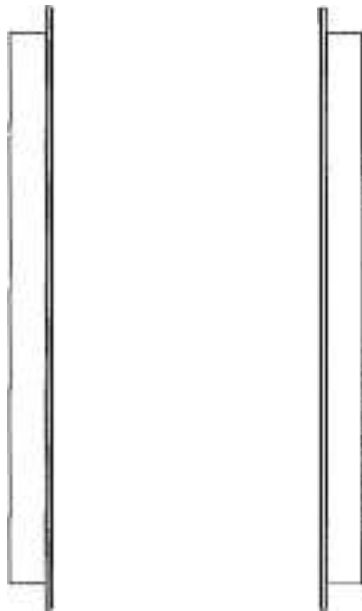

**Verlängerungen  
Prolongations  
Prolongazioni**

116 443	Cl.	09-05	1 Design
116 554	Cl.	07-04	2 Design
116 557	Cl.	09-05	1 Design
119 836	Cl.	10-01	3 Design



RW1



K 1

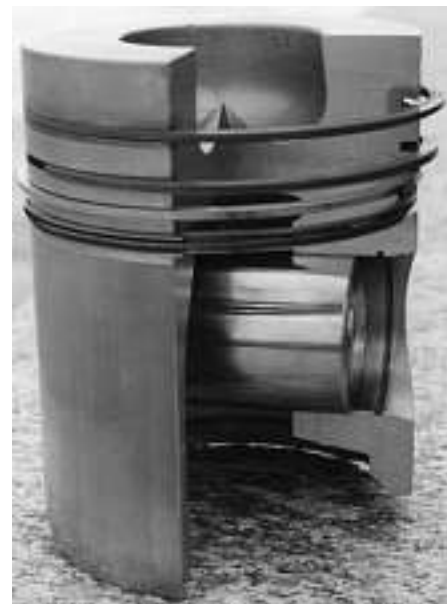



K2

120 146 Cl. 09-03 1 design



1

120 325 Cl. 13-02 2 design

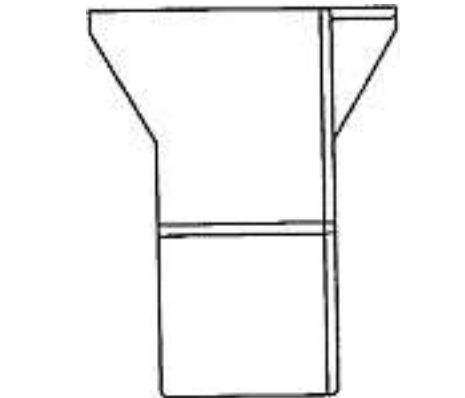
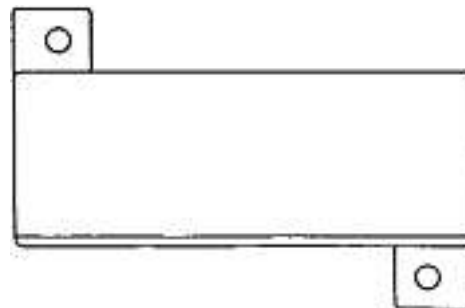
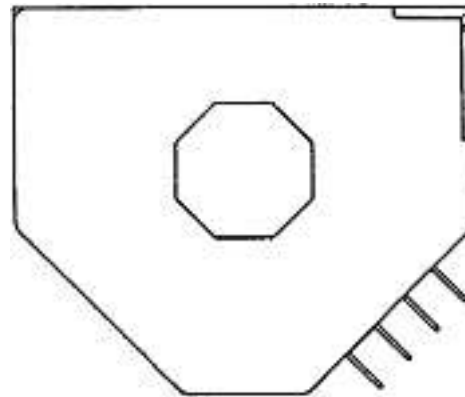
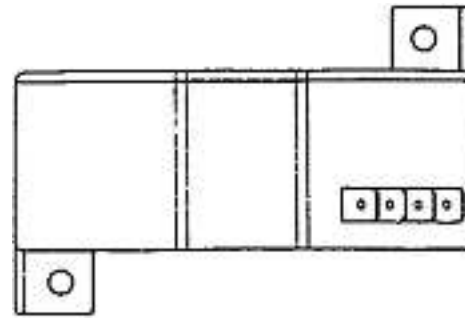
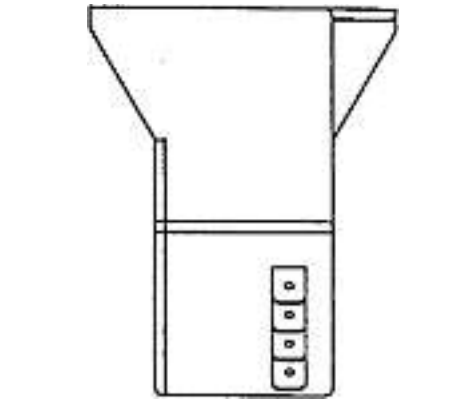
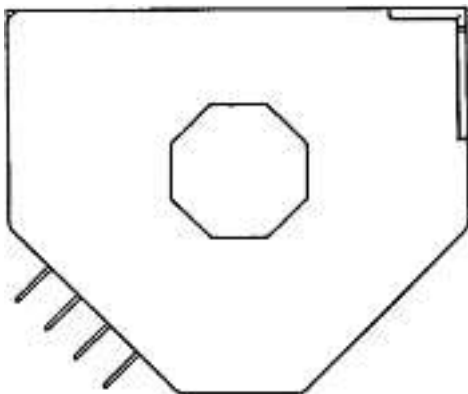

1

120 409 Cl. 09-01 1 Design

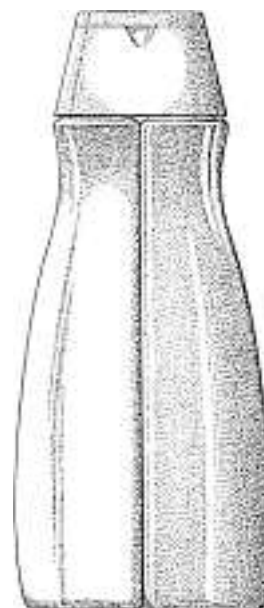
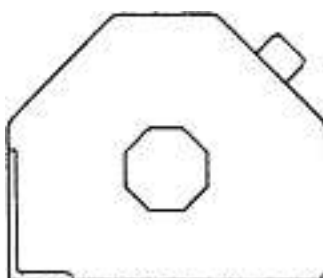
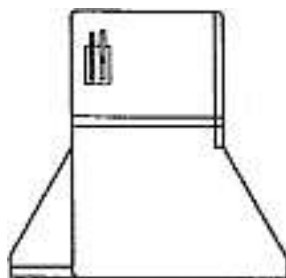
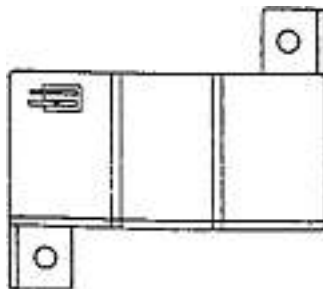
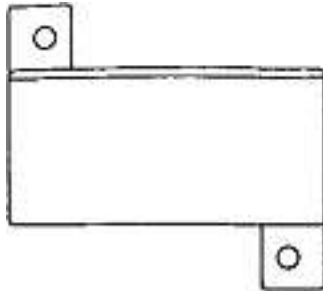
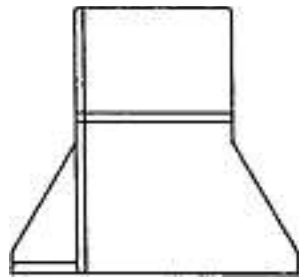

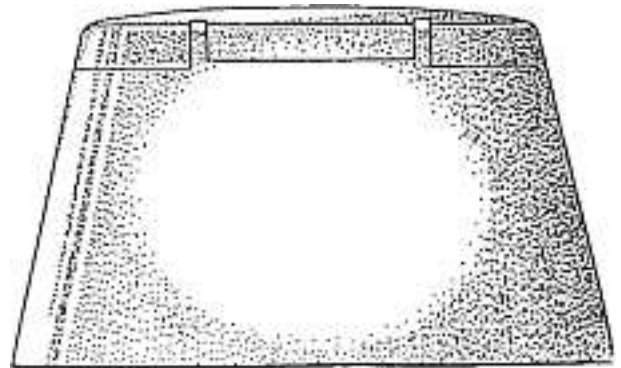
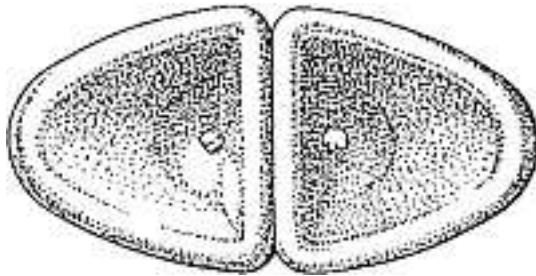
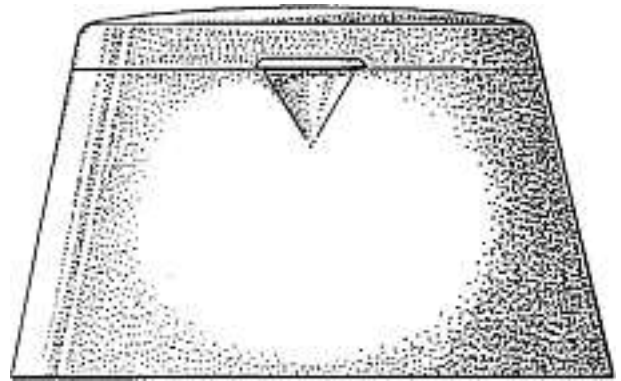
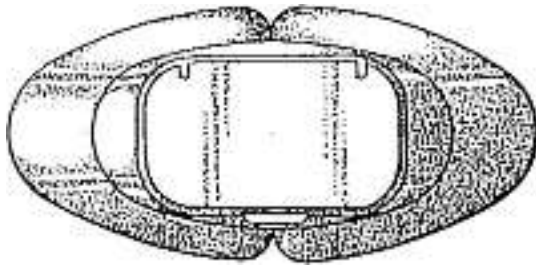
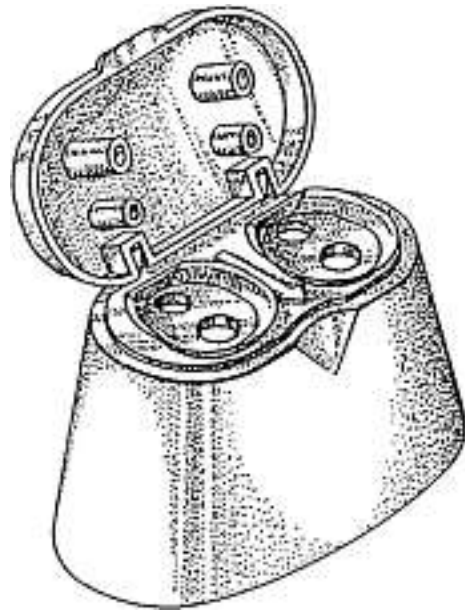

1

120 411 Cl. 09-07 1 Design

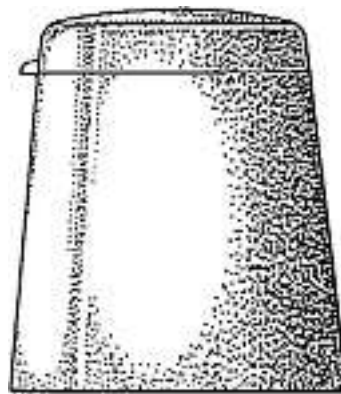
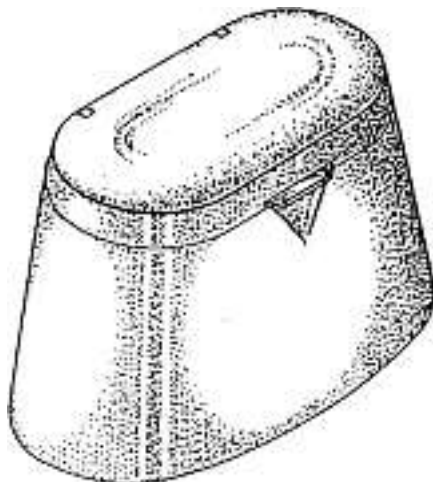

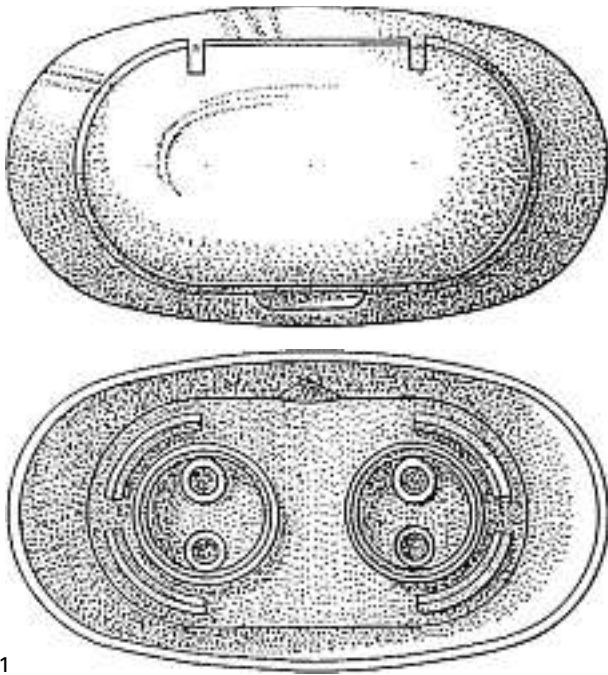

1

120 450 Cl. 09-01 1 Design



1

120 543 Cl. 09-01 2 design

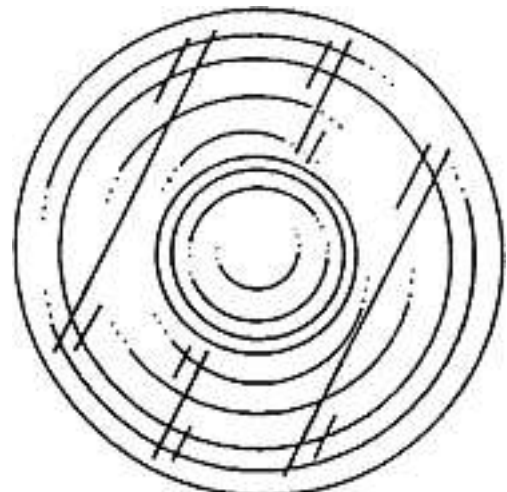
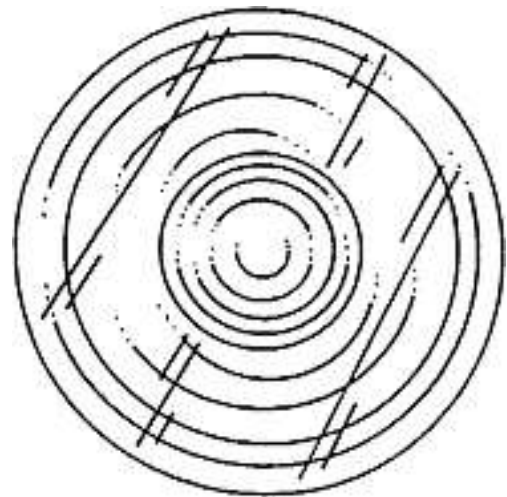
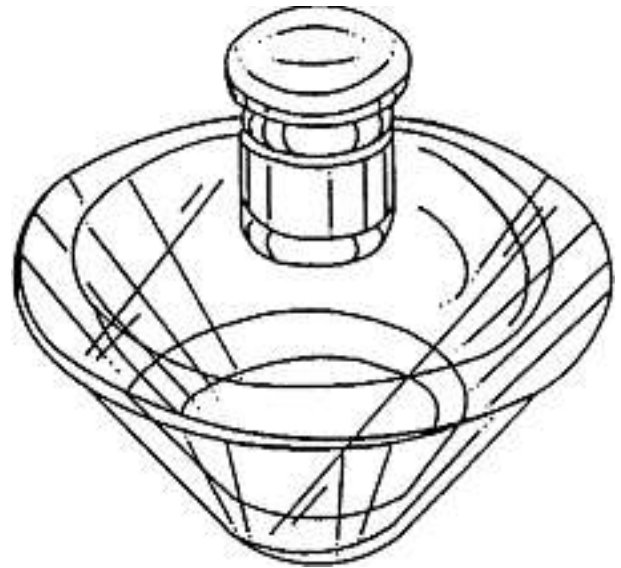
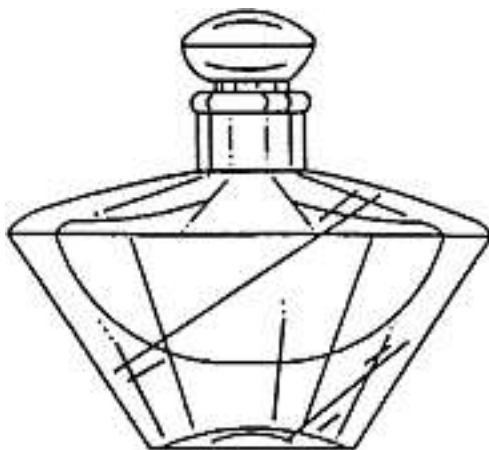

1

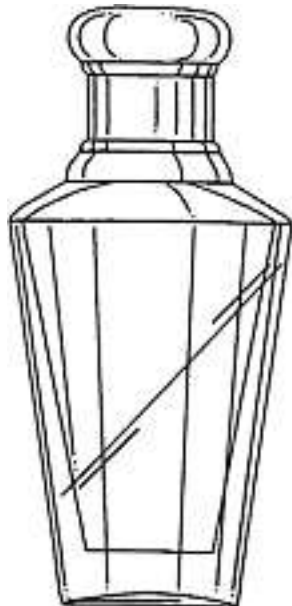
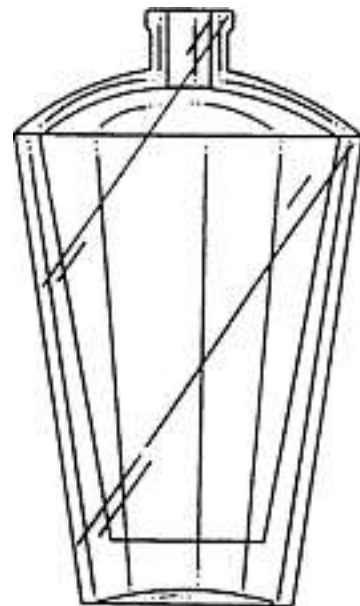
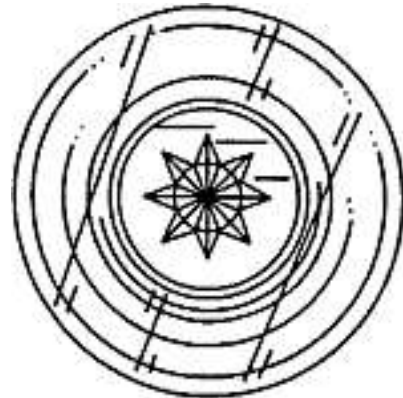
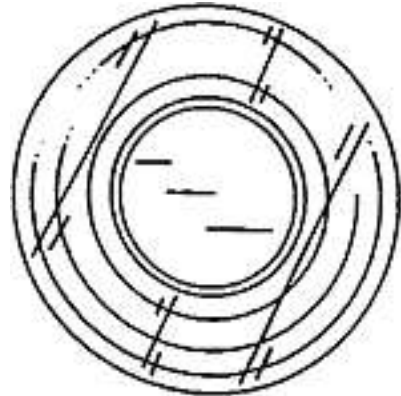
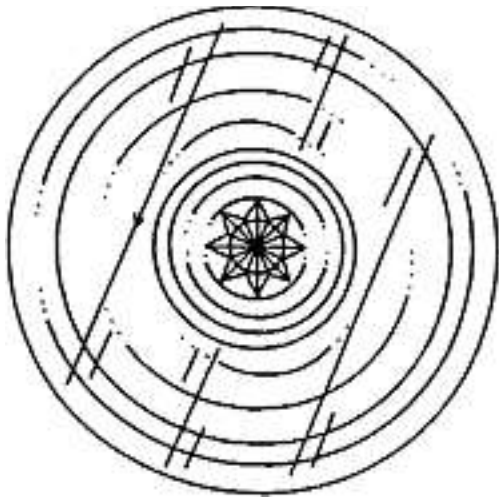

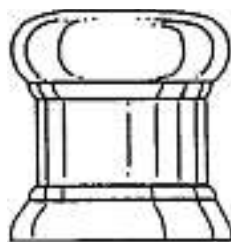

2

124 811	Cl.	07-02	4	Design
124 812	Cl.	07-02	4	Design
124 813	Cl.	07-02	4	Design
124 844	Cl.	07-01	1	Design
124 925	Cl.	07-04	1	Design
124 932	Cl.	12-12	2	Design
124 954	Cl.	04-02	1	Design
124 964	Cl.	06-07	5	Design
125 004	Cl.	03-01	1	Design
125 049	Cl.	04-02	1	Design
125 050	Cl.	04-02	1	Design
125 051	Cl.	04-02	1	Design
125 052	Cl.	04-02	1	Design
125 066	Cl.	07-02	1	design
125 092	Cl.	24-02	1	design
125 113	Cl.	09-01	3	design
125 136	Cl.	04-02	1	Design
125 137	Cl.	04-02	1	Design
125 169	Cl.	19-08	2	Design
129 345	Cl.	07-01	3	Design
129 346	Cl.	07-01	1	Design
129 347	Cl.	07-01	1	Design
129 349	Cl.	07-01	3	Design
129 350	Cl.	07-01	3	Design
129 351	Cl.	07-02	1	Design
129 352	Cl.	07-02	1	Design
129 354	Cl.	07-04	1	Design
129 360	Cl.	09-03	12	Design
129 370	Cl.	15-06	1	Design
129 446	Cl.	02-04	1	Design
129 464	Cl.	06-06	2	Design
129 511	Cl.	11-01	2	Design
129 514	Cl.	14-03	1	Design
129 524	Cl.	25-02	4	design
129 526	Cl.	26-02	2	design
129 545	Cl.	06-03	1	Design
129 546	Cl.	06-03	1	Design
129 553	Cl.	07-01	1	Design
129 556	Cl.	09-03	1	design
129 586	Cl.	25-01	1	Design
129 599	Cl.	07-01	1	Design
129 626	Cl.	14-02	1	Design
129 627	Cl.	14-02	1	Design
129 630	Cl.	15-02	1	Design
129 742	Cl.	10-01	2	Design
129 748	Cl.	19-08	2	Design

## Mutationen Modifications Modificazioni

### 122 242

Übertragung  
Hinterleger: Ultradent Products, Inc., 505 West 10200 South,  
South Jordan, Utah 84095, US  
Vertreter: Ammann Patentanwälte AG Bern, 3001 Bern

### 125 113

Nouveau mandataire  
Mandataire: E. Blum & Co. AG, Patent- und Markenanwälte  
VSP, 8044 Zürich

### 127 828

### 127 936

### 130 560

Vertreter Firmaänderung  
Vertreter: NEOVIUS Schlager & Partner, Advokaten & Notare,  
4010 Basel

### 131 854

Namensänderung  
Hinterleger: Acrostak Corp. BVI, c/o Acrostak AG,  
Stegackerstrasse 14, 8409 Winterthur

### 132 298

Transmission  
Déposant: YSL BEAUTE, 28/34 Boulevard du Parc,  
92521 Neuilly-sur-Seine Cedex, FR  
Mandataire: Griffes Consulting S.A., 1206 Genève

### 134 643

Nouveau mandataire  
Mandataire: Cabinet Germain & Maureau, 2028 Vaumarcus



**Löschungen  
Radiations  
Radiazioni**

116 119	Cl.	06-01	9 Design
116 120	Cl.	07-01	2 Design
119 865	Cl.	06-03	3 Design
119 908	Cl.	12-02	1 design
124 330	Cl.	07-02	1 Design
124 372	Cl.	07-05	1 Design
124 373	Cl.	07-05	1 Design
124 374	Cl.	07-05	1 Design
124 399	Cl.	24-02	1 Design
124 430	Cl.	14-02	1 Design
124 431	Cl.	14-03	2 Design
124 435	Cl.	20-01	1 Design
128 976	Cl.	07-04	1 Design
128 977	Cl.	07-99	3 Design
128 983	Cl.	09-03	1 Design
128 984	Cl.	10-02	1 Design
128 986	Cl.	13-02	1 design
128 990	Cl.	30-03	3 Design
129 006	Cl.	11-02	1 Design
129 015	Cl.	19-08	1 design
129 047	Cl.	09-04	1 Design
129 074	Cl.	09-05	2 Design
129 085	Cl.	25-01	1 Design

**Berichtigungen  
Rectifications  
Rettifiche**

**134 209**  
Rettifica del depositante:  
Jal Group Italia s.r.l.